

BLOOM: A 176B-Parameter Open-Access Multilingual Language Model

BigScience Workshop*

Major Contributors

Teven Le Scao, Angela Fan, Christopher Akiki, Ellie Pavlick, Suzana Ilić, Daniel Hesslow, Roman Castagné, Alexandra Sasha Luccioni, François Yvon, Matthias Gallé, Jonathan Tow, Alexander M. Rush, Stella Biderman, Albert Webson, Pawan Sasanka Ammanamanchi, Thomas Wang, Benoît Sagot, Niklas Muennighoff, Albert Villanova del Moral, Olatunji Ruwase, Rachel Bawden, Stas Bekman, Angelina McMillan-Major, Thomas Wolf, Iz Beltagy, Huu Nguyen, Lucile Saulnier, Samson Tan, Pedro Ortiz Suarez, Victor Sanh, Hugo Laurençon, Yacine Jernite, Julien Launay, Margaret Mitchell, Colin Raffel

Dataset

Aaron Gokaslan, Adi Simhi, Aitor Soroa, Albert Villanova del Moral, Alexandra Sasha Luccioni, Alham Fikri Aji, Amit Alfassy, Angelina McMillan-Major, Anna Rogers, Ariel Kreisberg Nitzav, Canwen Xu, Chenghao Mou, Chris Emezue, Christopher Akiki, Christopher Klamm, Colin Leong, Colin Raffel, Daniel van Strien, David Ifeoluwa Adelani, Dragomir Radev, Eduardo González Ponferrada, Efrat Levkovizh, Ethan Kim, Eyal Bar Natan, Francesco De Toni, Gérard Dupont, Germán Kruszewski, Giada Pistilli, Hady Elsahar, Hamza Benyamina, Hieu Tran, Hugo Laurençon, Huu Nguyen, Ian Yu, Idris Abdulmumin, Isaac Johnson, Itziar Gonzalez-Dios, Javier de la Rosa, Jenny Chim, Jesse Dodge, Jian Zhu, Jonathan Chang, Jörg Frohberg, Joseph Tobing, Joydeep Bhattacharjee, Khalid Almubarak, Kimbo Chen, Kyle Lo, Leandro Von Werra, Leon Weber, Long Phan, Loubna Ben allal, Lucile Saulnier, Ludovic Tanguy, Manan Dey, Manuel Romero Muñoz, Maraim Masoud, Margaret Mitchell, María Grandury, Mario Šaško, Max Huang, Maximin Coavoux, Mayank Singh, Mike Tian-Jian Jiang, Minh Chien Vu, Mohammad A. Jauhar, Mustafa Ghaleb, Nishant Subramani, Nora Kassner, Nurulaqilla Khamis, Olivier Nguyen, Omar Espejel, Ona de Gibert, Paulo Villegas, Pawan Sasanka Ammanamanchi, Pedro Ortiz Suarez, Peter Henderson, Pierre Colombo, Priscilla Amuok, Quentin Lhoest, Rheza Harliman, Rishi Bommasani, Roberto Luis López, Roman Castagné, Rui Ribeiro, Salomey Osei, Sampo Pyysalo, Samson Tan, Sebastian Nagel, Shamik Bose, Shamsuddeen Hassan Muhammad, Shanya Sharma, Shayne Longpre, Somaieh Nikpoor, Stanislav Silberberg, Stella Biderman, Suhas Pai, Suzana Ilić, Sydney Zink, Teven Le Scao, Thomas Wang, Tiago Timponi Torrent, Timo Schick, Tristan Thrush, Valentin Danchev, Vassilina Nikoulina, Veronika Laippala, Violette Lepercq, Vrinda Prabhu, Yacine Jernite, Zaid Alyafeai, Zeerak Talat

Tokenization

Arun Raja, Benjamin Heinzerling, Benoît Sagot, Chenglei Si, Colin Raffel, Davut Emre Taşar, Elizabeth Salesky, Lucile Saulnier, Manan Dey, Matthias Gallé, Pedro Ortiz Suarez, Roman Castagné, Sabrina J. Mielke, Samson Tan, Teven Le Scao, Thomas Wang, Wilson Y. Lee, Zaid Alyafeai

Prompt Engineering

Abheesht Sharma, Albert Webson, Alexander M. Rush, Alham Fikri Aji, Andrea Santilli, Antoine Chaffin, Arnaud Stiegler, Arun Raja, Canwen Xu, Colin Raffel, Debajyoti Datta, Dragomir Radev, Eliza Szczechla, Gunjan Chhablani, Han Wang, Harshit Pandey, Hendrik Strobelt, Jason Alan Fries, Jonathan Chang, Jos Rozen, Khalid Almubarak, Leo Gao, Lintang Sutawika, M Saiful Bari, Maged S. Al-shaibani, Manan Dey, Matteo Manica, Mike Tian-Jian Jiang, Nihal Nayak, Niklas Muennighoff, Rachel Bawden, Ryan Teehan, Samuel Albanie, Shanya Sharma, Sheng Shen, Srulik Ben-David, Stella Biderman, Stephen H. Bach, Taewoon Kim, Tali Bers, Teven Le Scao, Thibault Fevry, Thomas Wang, Thomas Wolf, Trishala Neeraj, Urmish Thakker, Victor Sanh, Vikas Raunak,

*. Please direct correspondence to bigscience-contact@googlegroups.com. A list of contributions is available in section 6.

Xiangru Tang, Zaid Alyafeai, Zheng-Xin Yong, Zhiqing Sun, Shaked Brody, Yallow Uri, Hadar Tojarieh

Architecture and Objective

Adam Roberts, Colin Raffel, Daniel Hesslow, Hady Elsahar, Hyung Won Chung, Iz Beltagy, Jaesung Tae, Jason Phang, Julien Launay, Lintang Sutawika, Lucile Saulnier, M Saiful Bari, Niklas Muennighoff, Ofir Press, Sheng Shen, Stas Bekman, Stella Biderman, Teven Le Scao, Thomas Wang, Vassilina Nikoulina, Victor Sanh, Zheng-Xin Yong

Engineering

Conglong Li, Deepak Narayanan, Hatim Bourfoune, Jared Casper, Jeff Rasley, Max Ryabini, Mayank Mishra, Minjia Zhang, Mohammad Shoeybi, Myriam Peyrounette, Nicolas Patry, Niklas Muennighoff, Nouamane Tazi, Olatunji Ruwase, Omar Sanseviero, Patrick von Platen, Pierre Cornette, Pierre François Lavallée, Rémi Lacroix, Samyam Rajbhandari, Sanchit Gandhi, Shaden Smith, Stas Bekman, Stéphane Requena, Suraj Patil, Teven Le Scao, Thomas Wang, Tim Dettmers

Evaluation and Interpretability

Ahmed Baruwa, Albert Webson, Alexandra Sasha Luccioni, Alham Fikri Aji, Amanpreet Singh, Anastasia Cheveleva, Anne-Laure Ligozat, Arjun Subramonian, Aurélie Névéol, Charles Lovering, Dan Garrette, Deepak Tunuguntla, Dragomir Radev, Ehud Reiter, Ekaterina Taktasheva, Ekaterina Voloshina, Eli Bogdanov, Ellie Pavlick, François Yvon, Genta Indra Winata, Hailey Schoelkopf, Jaesung Tae, Jan-Christoph Kalo, Jekaterina Novikova, Jessica Zosa Forde, Jordan Clive, Jungo Kasai, Ken Kawamura, Khalid Almubarak, Liam Hazan, Lintang Sutawika, Manan Dey, Maraim Masoud, Margaret Mitchell, Marine Carpuat, Miruna Clinciu, Najoung Kim, Newton Cheng, Niklas Muennighoff, Oleg Serikov, Omer Antverg, Oskar van der Wal, Pawan Sasanka Ammanamanchi, Pierre Colombo, Rachel Bawden, Rui Zhang, Ruochen Zhang, Samson Tan, Sebastian Gehrmann, Shachar Mirkin, Shani Pais, Shanya Sharma, Shayne Longpre, Stella Biderman, Tatiana Shavrina, Thomas Scialom, Tian Yun, Tomasz Limisiewicz, Urmish Thakker, Vassilina Nikoulina, Verena Rieser, Vikas Raunak, Vitaly Protasov, Vladislav Mikhailov, Wilson Y. Lee, Yada Pruksachatkun, Yonatan Belinkov, Zachary Bamberger, Zdeněk Kasner, Zeerak Talat, Zheng-Xin Yong

Broader Impacts

Aaron Gokaslan, Alexandra Sasha Luccioni, Alham Fikri Aji, Alice Rueda, Amanda Pestana, Amir Feizpour, Ammar Khan, Amy Faranak, Ana Santos, Angelina McMillan-Major, Anthony Hevia, Antigona Unldreaj, Arash Aghagol, Arezoo Abdollahi, Aycha Tammour, Azadeh HajiHosseini, Bahareh Behroozi, Benjamin Ajibade, Bharat Saxena, Carlos Muñoz Ferrandis, Chenghao Mou, Minh Chien Vu, Christopher Akiki, Danish Contractor, David Ifeoluwa Adelani, David Lansky, Davis David, Douwe Kiela, Duong A. Nguyen, Edward Tan, Emi Baylor, Ezinwanne Ozoani, Fatima Mirza, Frankline Ononiwu, Gérard Dupont, Giada Pistilli, Habib Rezanejad, Hessie Jones, Huu Nguyen, Ian Yu, Indrani Bhattacharya, Irene Solaiman, Irina Sedenko, Isar Nejadgholi, Jaesung Tae, Jenny Chim, Jesse Dodge, Jesse Passmore, Josh Seltzer, Julien Launay, Julio Bonis Sanz, Khalid Almubarak, Livia Dutra, Long Phan, Mairon Samagaio, Manan Dey, Maraim Elbadri, Maraim Masoud, Margaret Mitchell, Margot Mieskes, Marissa Gerchick, Martha Akinlolu, Michael McKenna, Mike Qiu, Muhammed Ghauri, Mykola Burynek, Nafis Abrar, Nazneen Rajani, Niklas Muennighoff, Nishant Subramani, Nour Elkott, Nour Fahmy, Olanrewaju Samuel, Olivier Nguyen, Paulo Villegas, Pawan Sasanka Ammanamanchi, Priscilla Amuok, Ran An, Rasmus Kromann, Ryan Hao, Samira Alizadeh, Sarmad Shubber, Shanya Sharma, Shayne Longpre, Silas Wang, Somaieh Nikpoor, Sourav Roy, Stas Bekman, Stella Biderman, Suhas Pai, Suzana Ilić, Sylvain Viguié, Teven Le Scao, Thanh Le, Tobi Oyeade, Trieu Le, Tristan Thrush, Yacine Jernite, Yoyo Yang, Zach Nguyen, Zeerak Talat, Zheng-Xin Yong

Applications

Abhinav Ramesh Kashyap, Albert Villanova del Moral, Alfredo Palasciano, Alison Callahan, Anima Shukla, Antonio Miranda-Escalada, Ayush Singh, Benjamin Beilharz, Bo Wang, Caio Brito, Carlos

Muñoz Ferrandis, Chenxi Zhou, Chirag Jain, Christopher Akiki, Chuxin Xu, Clémentine Fourier, Daniel León Periñán, Daniel Molano, Daniel van Strien, Danish Contractor, David Lansky, Debajyoti Datta, Dian Yu, Enrique Manjavacas, Fabio Barth, Florian Fuhrmann, Francesco De Toni, Gabriel Altay, Giyaseddin Bayrak, Gully Burns, Helena U. Vrabec, Imane Bello, Ishani Dash, Jason Alan Fries, Javier de la Rosa, Jenny Chim, Jihyun Kang, John Giorgi, Jonas Golde, Jose David Posada, Karthik Rangasai Sivaraman, Leon Weber, Lokesh Bulchandani, Lu Liu, Luisa Shinzato, Madeleine Hahn de Bykhovetz, Maiko Takeuchi, Marc Pàmies, Maria A Castillo, Marianna Nezhurina, Mario Sängler, Matthias Samwald, Michael Cullan, Michael Weinberg, Michiel De Wolf, Mina Mihaljcic, Minh Chien Vu, Minna Liu, Moritz Freidank, Myungsun Kang, Natasha Seelam, Nathan Dahlberg, Nicholas Michio Broad, Nikolaus Muellner, Pascale Fung, Patrick Haller, Ramya Chandrasekhar, Renata Eisenberg, Robert Martin, Rodrigo Canalli, Rosaline Su, Ruisi Su, Samuel Cahyawijaya, Samuele Garda, Shamik Bose, Shlok S Deshmukh, Shubhanshu Mishra, Sid Kiblawi, Simon Ott, Sinee Sang-aroonsiri, Srishti Kumar, Stefan Schweter, Stella Biderman, Stephen H. Bach, Sushil Bharati, Tanmay Laud, Théo Gigant, Tomoya Kainuma, Trishala Neeraj, Wojciech Kusa, Yanis Labrak, Yash Shailesh Bajaj, Yash Venkatraman, Yifan Xu, Yingxin Xu, Yu Xu, Zhe Tan, Zhongli Xie, Zifan Ye

Organization

Angela Fan, Christopher Akiki, Douwe Kiela, Giada Pistilli, Margot Mieskes, Mathilde Bras, Matthias Gallé, Suzana Ilić, Yacine Jernite, Younes Belkada, Thomas Wolf

Abstract

Large language models (LLMs) have been shown to be able to perform new tasks based on a few demonstrations or natural language instructions. While these capabilities have led to widespread adoption, most LLMs are developed by resource-rich organizations and are frequently kept from the public. As a step towards democratizing this powerful technology, we present BLOOM, a 176B-parameter open-access language model designed and built thanks to a collaboration of hundreds of researchers. BLOOM is a decoder-only Transformer language model that was trained on the ROOTS corpus, a dataset comprising hundreds of sources in 46 natural and 13 programming languages (59 in total). We find that BLOOM achieves competitive performance on a wide variety of benchmarks, with stronger results after undergoing multitask prompted finetuning. To facilitate future research and applications using LLMs, we publicly release our models and code under the Responsible AI License.¹

Keywords: Language models, collaborative research

1. Introduction

Pretrained language models have become a cornerstone of modern natural language processing (NLP) pipelines because they often produce better performance from smaller quantities of labeled data. The development of ELMo (Peters et al., 2018), ULMFiT (Howard and Ruder, 2018), GPT (Radford et al., 2018), and BERT (Devlin et al., 2019) led to the widespread use of pretrained models as an initialization for finetuning on downstream tasks. The subsequent finding that pretrained language models can perform useful tasks without any additional training (Radford et al., 2019; Brown et al., 2020) further demonstrated their utility. In addition, the empirical observation that a language model’s performance tends to increase as the model is made larger—sometimes predictably (Hestness et al., 2017; Kaplan

1. hf.co/bigscience/bloom

et al., 2020; Hoffmann et al., 2022) and sometimes suddenly (Wei et al., 2022)—has led to a trend of increasing scale (Zeng et al., 2021; Rae et al., 2021; Smith et al., 2022; Chowdhery et al., 2022). Apart from environmental concerns (Strubell et al., 2019; Lacoste et al., 2019; Schwartz et al., 2020), the costs of training large language models (LLMs) are only affordable for well-resourced organizations. Furthermore, until recently, most LLMs were not publicly released. As a result, the majority of the research community has been excluded from the development of LLMs. This exclusion has had concrete consequences; for example, most LLMs are primarily trained on English-language text (with notable exceptions in Chinese and Korean, e.g. Wang et al., 2021; Zeng et al., 2021; Kim et al., 2021).

To address these issues, we present the BigScience Large Open-science Open-access Multilingual Language Model (BLOOM, BigScience Workshop, 2022). BLOOM is a 176 billion parameter language model trained on 46 natural languages and 13 programming languages that was developed and released by a collaboration of hundreds of researchers. The compute for training BLOOM was provided through a French public grant from GENCI and IDRIS, leveraging IDRIS’ Jean Zay supercomputer. To build BLOOM, we undertook a thorough design process for each of its components, including the training dataset (Section 3.1), model architecture and training objective (Section 3.2), and engineering strategy for distributed learning (Section 3.4). We also performed an analysis of the model’s capabilities (Section 4). Our overall aim is not only to publicly release a large-scale multilingual language model with performance comparable to recently developed systems, but also to document the coordinated process that went into its development (Section 2.2). The purpose of this paper is to provide a high-level overview of these design steps while referencing the individual reports we produced over the course of developing BLOOM.

2. Background

Before describing the BLOOM model itself, in this section we provide necessary background on LLMs as well as an organizational overview of the BigScience effort.

2.1 Language Modeling

Language modeling refers to the task of modeling the probability of a sequence of tokens in a text (Shannon, 1948), where a token is a unit of text (e.g. word, subword, character or byte, etc., as discussed by Mielke et al., 2021). In this work (and in most current applications of language modeling) we model the joint probability of tokens in a text as:

$$p(x) = p(x_1, \dots, x_T) = \prod_{t=1}^T p(x_t | x_{<t}) \quad (1)$$

where x is a sequence of tokens, x_t is the t^{th} token, and $x_{<t}$ is the sequence of tokens preceding x_t . This approach is referred to as autoregressive language modeling and can be seen as iteratively predicting the probability of the next token.

Early Language Models Language models have a long history of application in NLP. Early language models (such as those developed by Shannon, 1948) were primarily n -gram models that estimate the probability of a length- n sequence of tokens in accordance with

the number of times it appears in a training corpus. In practice, n -gram models face two major issues: first, they grow exponentially in size as n is increased; and second, they have no direct way of producing a probability for a sequence of tokens that does not appear in their training data. Advances on these problems enabled n -gram models to see widespread use across most areas of NLP (Goodman, 2001).

Neural Language Models An alternative to n -gram models, first proposed by Miikkulainen and Dyer (1991) and Schmidhuber and Heil (1996) and later popularized by Bengio et al. (2000), is to use a neural network to estimate the probability of the next token given prior tokens. While early work used feed-forward networks with a fixed-length history window, Mikolov et al. (2010); Sutskever et al. (2011); Graves (2013) proposed to use recurrent neural networks instead and found that this significantly improved performance. More recently, language models based on the Transformer architecture (Vaswani et al., 2017) were shown to be more effective than recurrent neural networks (Radford et al., 2018; Al-Rfou et al., 2019; Kaplan et al., 2020). Consequently, the Transformer has become the *de facto* choice for language models.

Transfer Learning In tandem with advances in language modeling using neural networks, NLP pipelines have increasingly adopted the framework of transfer learning. In transfer learning, the parameters of a model are first pretrained on a data-rich task before being finetuned on a downstream task. A historically common approach to obtaining pretrained parameters were word vectors (Mikolov et al., 2013) trained so that the dot product of co-occurring word vectors is large. However, subsequent work by Peters et al. (2018); Howard and Ruder (2018); Radford et al. (2018); Devlin et al. (2019) showed that the framework of Collobert et al. (2011), where the entire model is pretrained before being finetuned, can attain stronger performance. In particular, Radford et al. (2018); Devlin et al. (2019) demonstrated strong results using pretrained Transformer language models, prompting work on progressively better models (Liu et al., 2019; Yang et al., 2019; Lewis et al., 2020; Raffel et al., 2020; Zhang et al., 2019, etc.).

Few- and Zero-Shot Learning While finetuning a pretrained model remains an effective way of attaining high performance with limited labeled data, a parallel line of work has demonstrated that pretrained language models can be induced to perform tasks without any subsequent training. After Vinyals and Le (2015) observed limited task-performing behavior in a neural dialog model, Radford et al. (2019) later demonstrated that Transformer-based language models trained on text scraped from the web could perform various tasks to varying degrees. Notably, Radford et al. (2019) found that performance improved with model scale, inspiring work to characterize (Kaplan et al., 2020; Hoffmann et al., 2022) and exploit (Shoeybi et al., 2019; Brown et al., 2020; Smith et al., 2022; Chowdhery et al., 2022; Rae et al., 2021; Wang et al., 2021; Zeng et al., 2021; Zhang et al., 2022) the benefits of scale. A major factor in the success of this approach is the way that task-specific examples are formatted when fed into the model. Brown et al. (2020) popularized the idea of designing “prompts” that provide natural-language descriptions of the task and also allow inputting a few demonstrations of input-output behavior.

Social Limitations of LLM Development While the continued increase in the size of large language models has resulted in improvements across a wide range of tasks, it has also

exacerbated issues with their development and use (Bender et al., 2021). The computational expense of large models also prohibits the majority of the research community from participating in their development, evaluation and routine use. Moreover, the computational costs have also lead to concerns about the carbon footprint stemming from the training and use of large language models (Strubell et al., 2019; Lacoste et al., 2019; Schwartz et al., 2020; Bannour et al., 2021), and existing carbon footprint studies have likely under-estimated emissions (Bannour et al., 2021). Contributing to an increase in the global carbon footprint exacerbates climate change which most severely affects already-marginalized communities (Westra and Lawson, 2001). Furthermore, the concentration of resources within a handful of (typically industrial) institutions with primarily technical expertise hinders prospects for an inclusive, collaborative, and reliable governance of the technology. First, public narratives about the technology that are driven by industry actors can lead to inflated expectations about its suitability for use (Brennen, 2018; Brennen et al., 2022), leading to misaligned research and policy priorities (Raji et al., 2022) and potentially dire consequences in e.g. medical applications (Wong et al., 2021). Second, in a world mediated by technology, choices at all stages of its development end up shaping people’s lives in a way that can be most closely compared to regulations (Winner, 1977, 2017), albeit without the same explicit consultation of stakeholders in the process. When the development efforts are guided by prioritizing internal definitions of performance over their impact on society, the values of the developers come to be emphasized over those of the direct and indirect users (Birhane et al., 2022). Despite the substantial social dangers in allowing this technology to be developed unilaterally by corporations, EleutherAI (Phang et al., 2022) was the only non-corporate entity outside of China that was developing large language models before the BigScience Workshop was convened.

2.2 BigScience

Participants BLOOM’s development was coordinated by BigScience, an open research collaboration whose goal was the public release of an LLM. The project started after being awarded by GENCI a compute grant on its Jean Zay supercomputer at IDRIS/CNRS. It was initially built around a concerted effort from Hugging Face and the French NLP community (the “founding members”), and quickly opened up to grow into a broader international collaboration to support its aims of linguistic, geographical, and scientific diversity. In the end, over 1200 people registered as participants in BigScience and were given access to its communication channels. They had background not only in machine learning and computer science, but also linguistics, statistics, socio-cultural anthropology, philosophy, law, and other fields. Of those, hundreds of individuals have directly contributed to one of the project’s released artifacts. While the largest number of participants ultimately originated from the US, 38 countries were represented.

Organization The set of related research questions tackled by the BigScience effort was reflected in the project’s organization into working groups. Each working group comprised several participants with various levels of involvement, including chairs whose role was to self-organize around a specific aspect of the overall project. Importantly, participants were encouraged to join more than one working group in order to share experiences and information, which resulted in the set of 30 working groups presented in Figure 1. Most

of the working groups focused on tasks directly linked to the development of BLOOM. In addition, a few groups focused on the evaluation of LLMs and dataset development in specific domains, such as biomedical texts (Fries et al., 2022b) and historical texts (De Toni et al., 2022). A larger overview of the motivations behind this initiative, its history and some of the lessons learned can be found in Akiki et al. (2022).

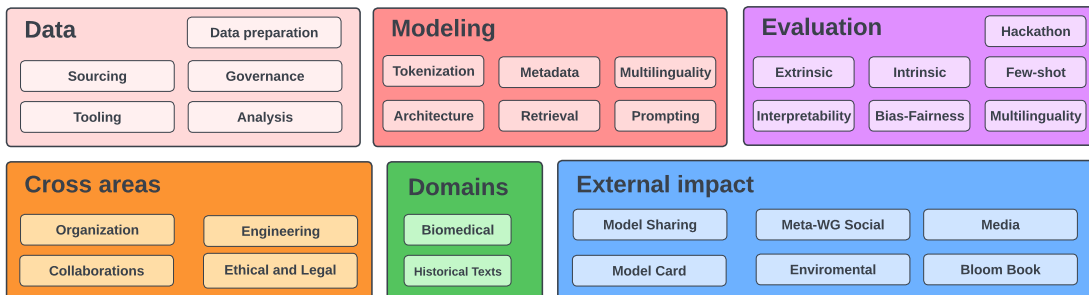

Figure 1: Organization of BigScience working groups.

Ethical Considerations within BigScience In order to acknowledge and start addressing social limitations of LLM development within BigScience, the workshop relied on a collaboratively designed Ethical Charter² and original research on applicable regulations in jurisdictions outside of the US³ to guide its choices throughout the project. In particular, the charter emphasizes values of **inclusivity and diversity**, **openness and reproducibility**, and **responsibility** in various aspects of the organization (Akiki et al., 2022). Each of these values are showcased in different ways in the dataset curation (Section 3.1), modeling (Section 3.2), engineering (Section 3.4), evaluation (Section 4), and other social impact (throughout) aspects of the project.

3. BLOOM

In this section, we document the design of BLOOM, including its training dataset (Section 3.1), architecture (Section 3.2), tokenizer (Section 3.3), computing infrastructure (Section 3.4), and training hyperparameters (Section 3.5).

3.1 Training Dataset

BLOOM was trained on the ROOTS corpus (Laurençon et al., 2022), a composite collection of 498 Hugging Face datasets (Lhoest et al., 2021) amounting to 1.61 terabytes of text that span 46 natural languages and 13 programming languages. A high-level overview of this dataset can be seen in Figure 3, while a detailed itemized list of every language along with its linguistic genus, family and macroarea is presented in Table 1. Beyond the corpus itself, the process resulted in the development and release of a number of organizational and technical tools, including those illustrated in Figure 2. The rest of this section will

². bigscience.huggingface.co/blog/bigscience-ethical-charter

³. bigscience.huggingface.co/blog/legal-playbook-for-natural-language-processing-researchers

Language	ISO-639-3	catalog-ref	Genus	Family	Macroarea	Size in Bytes
Akan	aka	ak	Kwa	Niger-Congo	Africa	70,1554
Arabic	arb	ar	Semitic	Afro-Asiatic	Eurasia	74,854,900,600
Assamese	asm	as	Indic	Indo-European	Eurasia	291,522,098
Bambara	bam	bm	Western Mande	Mande	Africa	391,747
Basque	eus	eu	Basque	Basque	Eurasia	2,360,470,848
Bengali	ben	bn	Indic	Indo-European	Eurasia	18,606,823,104
Catalan	cat	ca	Romance	Indo-European	Eurasia	17,792,493,289
Chichewa	nya	ny	Bantoid	Niger-Congo	Africa	1,187,405
chiShona	sna	sn	Bantoid	Niger-Congo	Africa	6,638,639
Chitumbuka	tum	tum	Bantoid	Niger-Congo	Africa	170,360
English	eng	en	Germanic	Indo-European	Eurasia	484,953,009,124
Fon	fon	fon	Kwa	Niger-Congo	Africa	2,478,546
French	fra	fr	Romance	Indo-European	Eurasia	208,242,620,434
Gujarati	guj	gu	Indic	Indo-European	Eurasia	1,199,986,460
Hindi	hin	hi	Indic	Indo-European	Eurasia	24,622,119,985
Igbo	ibo	ig	Igboid	Niger-Congo	Africa	14078,521
Indonesian	ind	id	Malayo-Sumbawan	Austronesian	Papunesia	19,972,325,222
isiXhosa	xho	xh	Bantoid	Niger-Congo	Africa	14,304,074
isiZulu	zul	zu	Bantoid	Niger-Congo	Africa	8,511,561
Kannada	kan	kn	Southern Dravidian	Dravidian	Eurasia	2,098,453,560
Kikuyu	kik	ki	Bantoid	Niger-Congo	Africa	359,615
Kinyarwanda	kin	rw	Bantoid	Niger-Congo	Africa	40,428,299
Kirundi	run	rn	Bantoid	Niger-Congo	Africa	3,272,550
Lingala	lin	ln	Bantoid	Niger-Congo	Africa	1,650,804
Luganda	lug	lg	Bantoid	Niger-Congo	Africa	4,568,367
Malayalam	mal	ml	Southern Dravidian	Dravidian	Eurasia	3,662,571,498
Marathi	mar	mr	Indic	Indo-European	Eurasia	1,775,483,122
Nepali	nep	ne	Indic	Indo-European	Eurasia	2,551,307,393
Northern Sotho	nso	nso	Bantoid	Niger-Congo	Africa	1,764,506
Odia	ori	or	Indic	Indo-European	Eurasia	1,157,100,133
Portuguese	por	pt	Romance	Indo-European	Eurasia	79,277,543,375
Punjabi	pan	pa	Indic	Indo-European	Eurasia	1,572,109,752
Sesotho	sot	st	Bantoid	Niger-Congo	Africa	751,034
Setswana	tsn	tn	Bantoid	Niger-Congo	Africa	1,502,200
Simplified Chinese	—	zhs	Chinese	Sino-Tibetan	Eurasia	261,019,433,892
Spanish	spa	es	Romance	Indo-European	Eurasia	175,098,365,045
Swahili	swh	sw	Bantoid	Niger-Congo	Africa	236,482,543
Tamil	tam	ta	Southern Dravidian	Dravidian	Eurasia	7,989,206,220
Telugu	tel	te	South-Central Dravidian	Dravidian	Eurasia	2993407,159
Traditional Chinese	—	zht	Chinese	Sino-Tibetan	Eurasia	762,489,150
Twi	twi	tw	Kwa	Niger-Congo	Africa	1,265,041
Urdu	urd	ur	Indic	Indo-European	Eurasia	2,781,329,959
Vietnamese	vie	vi	Viet-Muong	Austro-Asiatic	Eurasia	43,709,279,959
Wolof	wol	wo	Wolof	Niger-Congo	Africa	3,606,973
Xitsonga	tso	ts	Bantoid	Niger-Congo	Africa	707,634
Yoruba	yor	yo	Defoid	Niger-Congo	Africa	89,695,835
Programming Languages	—	—	—	—	—	174,700,245,772

Table 1: Linguistic makeup of the ROOTS corpus.

contextualize these efforts by providing a brief summary of the steps taken to compile the corpus. For more detailed documentation of the overall dataset curation process and its outcomes, we refer the reader to Laurençon et al. (2022).

Motivation The disconnect between developers and (in)voluntary users of the technology mentioned in Section 2 is particularly apparent in the curation of the datasets that have supported recent large-scale machine learning projects, where intentional “Data work” is generally under-valued (Sambasivan et al., 2021). In the context of LLMs, this tendency is exemplified by a range of heuristics-based filtering approaches that prioritize getting as much “high-quality” data for as little cost as possible over engaging with the needs—and rights—of data subjects, where quality is commonly defined as maximizing performance on downstream tasks while occasionally removing content deemed offensive by the developers.

While these approaches do yield terabytes of data with comparatively little human effort, compounding biases of the source material (such as CommonCrawl dumps) with those of the filtering method often leads to negative outcomes for marginalized populations. In one case, the use of a block list to remove “pornographic” text was shown to also suppress LGBTQ+ and African American English (AAE) text from a corpus (Dodge et al., 2021). In another, using Reddit outgoing links as an indicator of quality for a seed corpus (Radford et al., 2019) leads to trained models that implicitly prioritize US-centric views in their outputs (Johnson et al., 2022). In yet another project, a filtering approach that relied on a machine learning image-text alignment model was shown to exacerbate its biases in the created multimodal dataset (Birhane et al., 2021). In addition, this *abstractive* approach to data curation leads to corpora that are difficult to meaningfully document and govern after the fact, as the provenance and authorship of individual items is usually lost in the process (although works such as Gao et al. (2020) that prioritize compilations of previously documented individual sources over crawled data provide a step towards addressing these issues (Biderman et al., 2022)).

In the context of the BigScience workshop, and in accordance with its Ethical Charter,⁴ we aimed to prioritize human involvement, local expertise, and language expertise in our data curation and documentation process, as outlined in the following sections.

3.1.1 DATA GOVERNANCE

Large text corpora comprise text about and created by people: the data subjects. Different people and institutions might legally “own” that data, making them data rights-holders. As machine learning developers gather and collate that data into ever-larger datasets to support training larger models, it becomes increasingly important to develop new ways of accounting for the interests of all parties involved – developers, data subjects, and rights-holders alike.

The BigScience effort aimed to address these needs through a multidisciplinary lens combining technical, legal, and sociological expertise. The group focused on two main interrelated goals at two different time scales: the design of a structure for long-term international data governance that prioritizes the agency of the data rights-holders, and concrete recommendations for handling the data used directly in the BigScience project. Progress on the first goal is presented in the work of Jernite et al. (2022), which further motivates the needs and requirements of data governance, and outlines the structure needed for a network

4. bigscience.huggingface.co/blog/bigscience-ethical-charter

of data custodians, rights-holders, and other parties to appropriately govern shared data. The interactions between these actors are designed to account for the privacy, intellectual property, and user rights of the data and algorithm subjects in a way that aims to prioritize local knowledge and expression of guiding values. In particular, this approach relies on structured agreements between data providers and data hosts⁵ that specify what the data may be used for.

While we were not able to fully establish an international organization in the comparatively short time between the project start and model training, we worked on integrating lessons from this effort (and conversely adapting it to the practical concerns we were experiencing) in the following main ways: (i) we sought explicit permission to use the data from specific providers **within the context of BigScience** whenever possible (such as for the AI2⁶-managed S2ORC corpus of Lo et al. (2020) or articles from the French newspaper *Le Monde*⁷); (ii) we kept individual sources separate until the final stages of preprocessing to maintain traceability and handle each according to the needs of its specific context; and (iii) we adopted a composite release approach for the various data sources that make up the overall corpus to foster reproducibility and follow-up research while respecting these source-dependent needs. Resources to visualize and access the ROOTS corpus can be found on the Hugging Face Hub organization “BigScience Data”.⁸ The organization hosts several demos (or “Spaces”) that can be used to gain insights into the full corpus, as well as direct access to the 223 (out of 498) components that we are able to distribute taking into account their licensing status, privacy risks, and agreements with their original custodians. Finally, since we understand that future investigation into the BLOOM models may require full access to the entire corpus, we are also inviting researchers with a relevant research project in mind to join ongoing efforts to analyze the data through a sign-up form.⁹

3.1.2 DATA SOURCES

Given a strategy for data governance, the next step was to determine the composition of the training corpus. This stage was driven by several goals, which sometimes had inherent tensions. Some of those tensions included building a language model that was accessible to as many people as possible around the world while only including languages for which we had enough expertise to curate a dataset of comparable scale (and to a lesser extent composition) to previous efforts while improving the standards of documentation and respect for data and algorithm subject rights.

Language Choices These considerations led us to an incremental process for choosing which languages were to be included in the corpus. We started with a list of eight of the world’s largest languages by number of speakers for which we did active outreach in the early stages of the project to invite fluent speakers to join the data efforts. Then, on the recommendation of language communities (Nekoto et al., 2020) we expanded Swahili in the original selection to the category of Niger-Congo languages, and Hindi and Urdu to

5. hf.co/spaces/bigscience/data_host_provider_agreement

6. allennai.org

7. lemonde.fr

8. hf.co/bigscience-data

9. forms.gle/qyYswbEL5kA23Wu99

Indic languages (Kunchukuttan et al., 2020). Finally, we proposed that any group of 3 or more participants fluent in an additional language could add it to the supported list if they would commit to selecting sources and guiding processing choices in the language in order to avoid common issues with corpora selected through automatic language identification without specific language expertise (Caswell et al., 2022).

Source Selection The biggest part of the corpus was curated by workshop participants and research collectives who collectively compiled the “BigScience Catalogue”: a large list of processed and non-processed sources covering a wide range of languages. This took the form of hackathons that were co-organized by communities such as Machine Learning Tokyo, Masakhane, and LatinX in AI (McMillan-Major et al., 2022). Complementary to those efforts, other working group participants compiled language-specific resources such as the Arabic-focused Masader repository (Alyafeai et al., 2021; Altaher et al., 2022). A total of 252 sources were identified through this bottom-up approach, with at least 21 sources per language category. Additionally, in order to increase the geographic coverage of some of our Spanish, Chinese, French, and English sources, participants identified locally relevant websites in their language to be added to the corpus via pseudocrawl, a method to obtain those websites from a Common Crawl snapshot.

GitHub Code The catalogue was further complemented with a dataset of programming languages collected from the GitHub data collection on Google’s BigQuery,¹⁰ which was then deduplicated of exact matches. The choice of languages to include mirrored the design choices introduced by Li et al. (2022) to train the AlphaCode model.

OSCAR Both in an effort not to diverge from the standard research practice of using the Web as a source of pretraining data (Radford et al., 2018; Raffel et al., 2020), and also to satisfy the data volume needs of our compute budget given the size of BLOOM, we further sourced data from OSCAR version 21.09, corresponding to the February 2021 snapshot of the Common Crawl (Ortiz Suárez et al., 2019; Abadji et al., 2021), which ended up constituting 38% of the corpus.

3.1.3 DATA PREPROCESSING

After the sources had been identified, data processing involved several steps to handle multiple aspects of data curation. An overarching view of and processing pipeline to build ROOTS can be seen in Figure 2. All tools developed in the process are available on GitHub.¹¹

Obtaining the Source Data The first step involved obtaining the data for all of the text data sources identified in Section 3.1.2, which consisted of a combination of downloading and extracting the text field from a variety of NLP datasets in various formats (including e.g. question answering, summarization, or dialogue datasets), scraping and processing large amounts of PDF files from archives (e.g. the French repository of scientific articles¹²), and extracting and preprocessing text from 192 website entries from the catalogue and another

10. cloud.google.com/blog/topics/public-datasets/github-on-bigquery-analyze-all-the-open-source-code

11. github.com/bigscience-workshop/data-preparation

12. hal.archives-ouvertes.fr

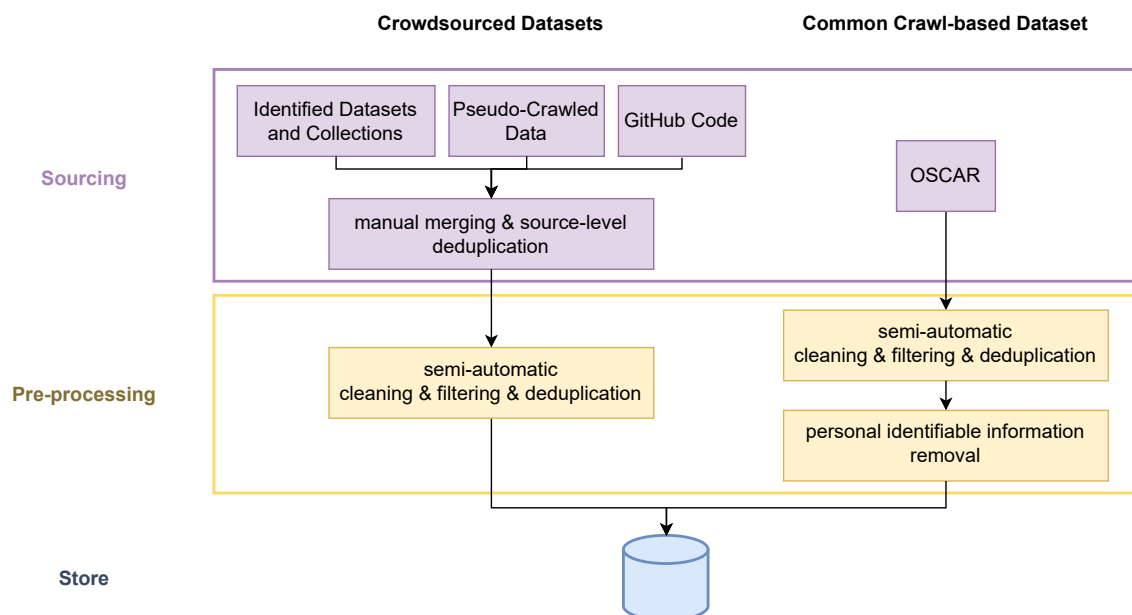

Figure 2: Creation Pipeline of the ROOTS Corpus. The purple-colored sourcing stage of the pipeline and the yellow-colored processing stage are described respectively in Section 3.1.2 and Section 3.1.3.

geographically diverse set of 456 websites selected by data working group members. The latter required the development of new tools to extract text from the HTML in the Common Crawl WARC files, which we made available on the main data preparation repository.¹³ We were able to find and extract usable text data from all URLs present in 539 of the websites.

“Quality” filtering: Text Produced by Humans for Humans After obtaining the text, we found that most of the sources contained some amount of text that was not natural language, for example preprocessing errors, SEO pages, or spam (including pornographic spam). In order to filter non-natural language, we defined a set of quality indicators, where high-quality text is defined as “written by humans for humans”, without distinction of content (as we wanted content selection to exclusively be the domain of the more accountable human source selection) or *a priori* judgments of grammaticality. The full list of indicators are described in (Laurençon et al., 2022). Importantly, the indicators were adapted to the needs of each of the sources in two main ways. First, their parameters such as the thresholds and supporting term lists were selected individually for each language by fluent speakers. Second, we manually went through each individual source to identify which indicators were most likely to identify non-natural language. Both processes were supported by tools to visualize their impact.^{14,15}

13. github.com/bigscience-workshop/data-preparation/tree/main/sourcing/cc_pseudo_crawl

14. hf.co/spaces/huggingface/text-data-filtering

15. hf.co/spaces/bigscience-data/process-pipeline-visualizer

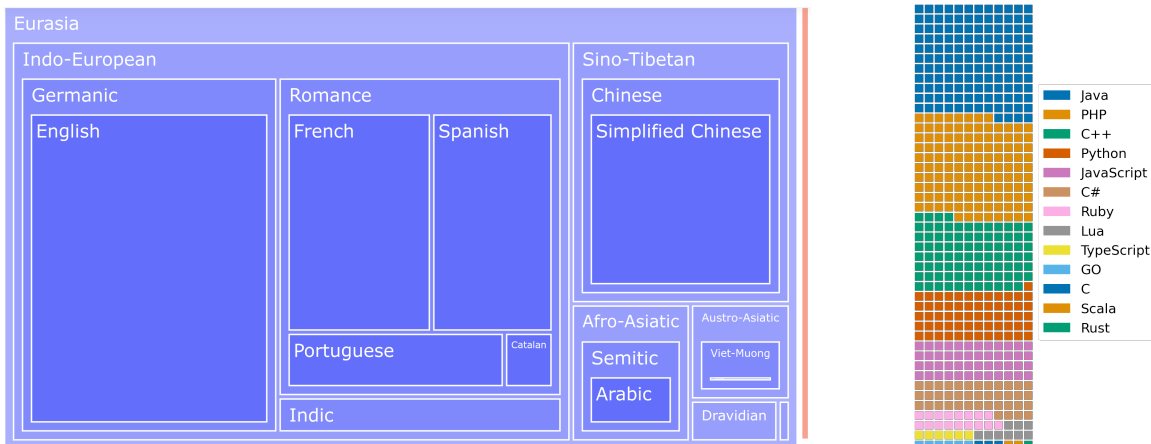

Figure 3: Graphical overview of the ROOTS corpus. **Left:** A treemap plot of the language families of all 46 natural languages where surface is proportional to the number of bytes. Indo-European and Sino-Tibetan families overwhelm the plot with a combined total of 1321.89 GB. The thin orange surface represents 18GB of Indonesian data and the green rectangle 0.4GB constituting the Niger-Congo language family subset. **Right:** A waffle plot of the distribution of the 13 programming languages by number of files, where one square represents approximately 30,000 files.

Deduplication and Privacy Redaction Finally, we removed near-duplicate documents with two deduplication steps and redacted Personal Identifiable Information (such as social security numbers) that we could identify from the OSCAR version of the corpus—as it was deemed to be the source that presented the highest privacy risks, prompting us to apply regex-based redaction even in cases where the expressions had some false positives.

3.1.4 PROMPTED DATASETS

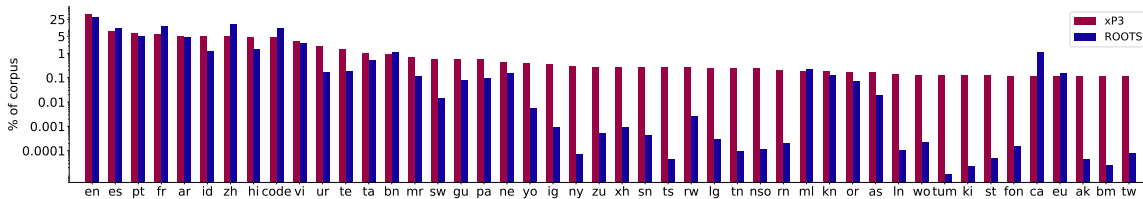

Figure 4: Language distribution of the prompted dataset xP3 closely follows ROOTS.

Multitask prompted finetuning (also referred to as instruction tuning) involves finetuning a pretrained language model on a training mixture composed of a large set of different tasks specified through natural language prompts. T0 (Sanh et al., 2022) (developed as part of BigScience) demonstrated that language models finetuned on a multitask mixture of prompted datasets have strong zero-shot task generalization abilities. Moreover, T0 was shown to outperform language models that are an order of magnitude larger but did not

undergo such finetuning. Motivated by these results, we explored using existing natural language datasets to carry out multitask prompted finetuning.

T0 was trained on a subset of the Public Pool of Prompts (P3), a collection of prompts for various existing and open-source English natural language datasets. This collection of prompts was created through a series of hackathons involving BigScience collaborators and where hackathon participants wrote a total of 2000+ prompts for 170+ datasets. Datasets in P3 cover a variety of natural language task including sentiment analysis, question answering, and natural language inference and exclude harmful content or non-natural language such as programming languages. PromptSource (Bach et al., 2022),¹⁶ an open-source toolkit (also developed as part of BigScience) facilitated creating, sharing and using natural language prompts. Full details of the collection process are given in (Sanh et al., 2022; Bach et al., 2022).

After pretraining BLOOM, we applied the same massively multitask finetuning recipe to equip BLOOM with multilingual zero-shot task generalization abilities. We refer to the resulting models as BLOOMZ. To train BLOOMZ, we extended P3 to include new datasets in languages other than English and new tasks, such as translation. This resulted in xP3, a collection of prompts for 83 datasets covering 46 languages and 16 tasks. As highlighted in Figure 4, xP3 mirrors the language distribution of ROOTS. Tasks in xP3 are both cross-lingual (e.g. translation) and monolingual (e.g. summarization, question answering). We used PromptSource to collect these prompts, adding additional metadata to the prompts, such as input and target languages. To study the importance of multilingual prompts, we also machine-translated English prompts in xP3 to the respective dataset languages to produce a collection called xP3mt. Further details on the prompt collection for xP3 and xP3mt are given in Muennighoff et al. (2022b).

3.2 Model Architecture

This section discusses our design methodology and the architecture of the BLOOM model. In-depth studies and experiments can be found in Le Scao et al. (2022) and Wang et al. (2022a). We first review our design methodology, then motivate our choice of training a causal decoder-only model. Finally, we justify the ways that our model architecture deviates from standard practice.

3.2.1 DESIGN METHODOLOGY

The design space of possible architectures is immense, making exhaustive exploration impossible. One option would be to exactly replicate the architecture of an existing large language model. On the other hand, a great deal of work on improving existing architectures has seen relatively little adoption (Narang et al., 2021); adopting some of these recommended practices could yield a significantly better model. We take a middle ground and focus on model families that have been shown to scale well, and that have reasonable support in publicly available tools and codebases. We ablate components and hyperparameters of the models, seeking to make the best use of our final compute budget.

16. github.com/bigscience-workshop/promptsource

Experimental Design for Ablations One of the main draws of LLMs has been their ability to perform tasks in a “zero/few-shot” way: large enough models can perform novel tasks simply from in-context instructions and examples (Radford et al., 2019), without dedicated training on supervised samples. Accordingly, and because finetuning a 100B+ model is unwieldy, we focused our evaluation of architectural decisions on zero-shot generalization, and do not consider transfer learning. Specifically, we measured zero-shot performance on diverse aggregates of tasks: 29 tasks from the EleutherAI Language Model Evaluation Harness (EAI-Eval, Gao et al. (2021)), and 9 tasks from the evaluation set of T0 (T0-Eval, Sanh et al. (2022)). There is significant overlap between the two: only one task from T0-Eval (StoryCloze) is not in EAI-Eval, although all prompts between the two are different. See Le Scao et al. (2022) for a detailed list of tasks and baselines. We also note that our tasks aggregates share 17 of the 31 tasks of the evaluation of GPT-3 (Brown et al., 2020).

We conducted our ablation experiments using smaller models. We used the 6.7B parameter scale for the pretraining objective ablations (Wang et al., 2022a) and the 1.3B scale for the rest including position embeddings, activations, and layer normalization (Le Scao et al., 2022). Recently, Dettmers et al. (2022) identified a phase transition for models larger than 6.7B, in which the emergence of “outliers features” is observed. This questions whether results obtained at the 1.3B scale should be assumed to extrapolate to our final model size.

Out-of-scope Architectures We did not consider mixture-of-experts (MoE) (Shazeer et al., 2017), due to a lack of widely used GPU-based codebases suitable for training them at scale. Similarly, we also did not consider state-space models (Gu et al., 2020). At the time of the design of BLOOM, they consistently underperformed in natural language tasks (Gu et al., 2021). Both of these approaches are promising, and have now demonstrated competitive results—at large scales for MoE (Fedus et al., 2022; Srivastava et al., 2022), and at smaller scale for state-space models with H3 (Anonymous, 2023).

3.2.2 ARCHITECTURE AND PRETRAINING OBJECTIVE

Although most modern language models are based on the Transformer architecture, there are significant deviations between architectural implementations. Notably, while the original Transformer is based on an encoder-decoder architecture, many popular models have opted for encoder-only (e.g. BERT, (Devlin et al., 2019)) or decoder-only (e.g. GPT, (Radford et al., 2018)) approaches. Currently, all state-of-the-art language models over 100 billion parameters are causal decoder-only models (Brown et al., 2020; Rae et al., 2021; Chowdhery et al., 2022). This is in opposition to the findings of Raffel et al. (2020), in which encoder-decoder models significantly outperform decoder-only models for transfer learning.

Prior to our work, the literature was lacking a systematic evaluation of the zero-shot generalization capabilities of different architectures and pretraining objectives. We explored this question in Wang et al. (2022a) where we evaluated encoder-decoder and decoder-only architectures and their interactions with causal, prefix, and masked language modeling pretraining objectives. Our results show that immediately after pretraining, causal decoder-only models performed best – validating the choice of state-of-the-art LLMs. Furthermore, they can be more efficiently adapted after pretraining to a non-causal architecture and objective—an approach which has been further explored and confirmed by Tay et al. (2022).

3.2.3 MODELING DETAILS

Beyond choosing an architecture and pretraining objective, a number of changes to the original Transformer architecture have been proposed. For example, alternative positional embedding schemes (Su et al., 2021; Press et al., 2021) or novel activation functions (Shazeer, 2020). We thus performed a series of experiments to evaluate the benefit of each of these modifications for a causal decoder-only model in Le Scao et al. (2022). We adopted two architectural deviations in BLOOM:

ALiBi Positional Embeddings Instead of adding positional information to the embedding layer, ALiBi directly attenuates the attention scores based on how far away the keys and queries are (Press et al., 2021). Although ALiBi was initially motivated by its ability to extrapolate to longer sequences, we found it also led to smoother training and better downstream performance even at the original sequence length – outperforming both learned (Vaswani et al., 2017) and rotary (Su et al., 2021) embeddings.

Embedding LayerNorm In preliminary experiments training a 104B parameters model, we experimented with an additional layer normalization immediately after the embedding layer – as recommended by the `bitsandbytes`¹⁷ library (Dettmers et al., 2022) with its `StableEmbedding` layer. We found this significantly improved training stability. Even though we also found it penalizes zero-shot generalization in Le Scao et al. (2022), we train BLOOM with an additional layer normalization after the first embedding layer to avoid training instabilities. Note the preliminary 104B experiments were conducted in `float16`, while the final training was in `bfloat16`. Since then, `float16` has been attributed as being responsible for many of the observed instabilities in training LLMs (Zhang et al., 2022; Zeng et al., 2022). It is possible that `bfloat16` alleviates the need for the embedding LayerNorm.

We represent the full architecture of BLOOM in figure 5 for reference.

3.3 Tokenization

The design decisions when training a tokenizer are often neglected in favour of “default” settings (Mielke et al., 2021). For instance, OPT (Zhang et al., 2022) and GPT-3 (Brown et al., 2020) both use GPT-2’s tokenizer, trained for English. This can be justified by the fact that evaluating the impact of a particular choice on the downstream performance of the model is constrained by the large computational costs of training. However, the diverse nature of BLOOM’s training data requires careful design choices to ensure that the tokenizer encodes sentences in a lossless manner.

Validation We use the fertility (Ács, 2019) of our tokenizer compared to existing monolingual tokenizers as a metric for sanity checks. Fertility is defined as the number of subwords created per word or per dataset by the tokenizer, which we measured using subsets of Universal Dependencies 2.9 (Nivre et al., 2017) and OSCAR (Ortiz Suárez et al., 2019) in the languages of interest. A very high fertility on a language compared to a monolingual tokenizer may indicate a degradation on the downstream multilingual performance of the model (Rust et al., 2021). Our goal was to not degrade the fertility on each language by more than 10 percentage points when comparing our multilingual tokenizer with monolingual to-

¹⁷ github.com/TimDettmers/bitsandbytes

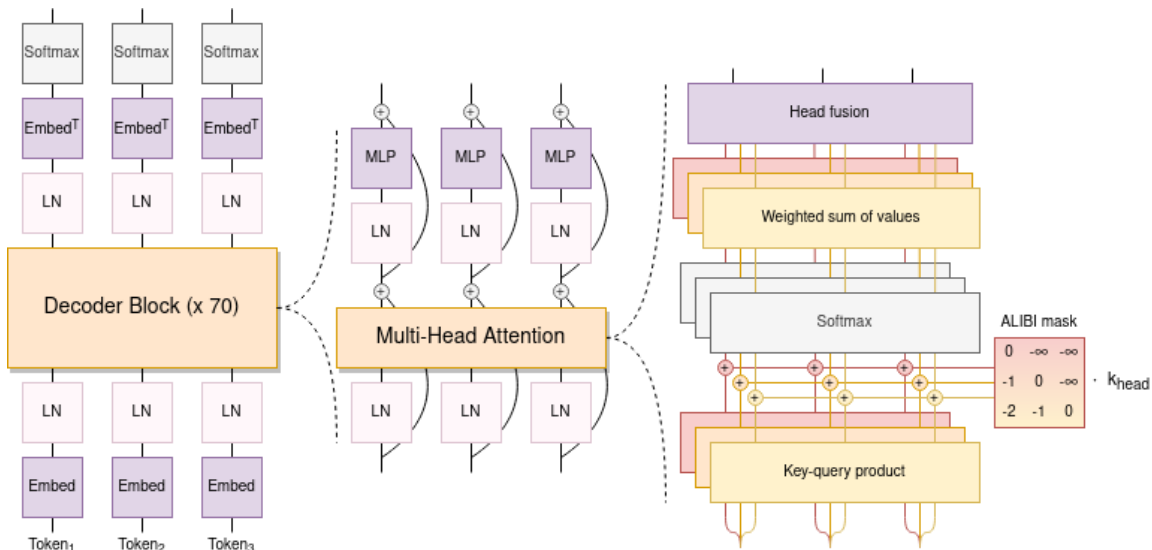

Figure 5: The BLOOM architecture. The k_{head} slope parameters for ALIBI are taken as $2 \frac{-8i}{n}$ with n the number of heads and $i \in 1, 2, \dots, n$.

tokenizers in corresponding languages. For all experiments, the Hugging Face Tokenizers library (Moi et al., 2019) was used to design and train the tested tokenizers.

Tokenizer	fr	en	es	zh	hi	ar
Monolingual	1.30	1.15	1.12	1.50	1.07	1.16
BLOOM	1.17 (-11%)	1.15 (+0%)	1.16 (+3%)	1.58 (+5%)	1.18 (+9%)	1.34 (+13%)

Table 2: Fertilities obtained on Universal Dependencies treebanks on languages with existing monolingual tokenizers. The monolingual tokenizers we used were the ones from CamemBERT (Martin et al., 2020), GPT-2 (Radford et al., 2019), DeepESP/gpt2-spanish, bert-base-chinese, monsoon-nlp/hindi-bert and Arabic BERT (Safaya et al., 2020), all available on the HuggingFace Hub.

Tokenizer Training Data We initially used a non-duplicated subset of ROOTS. However, a qualitative study on the vocabulary of the tokenizer revealed issues in its training data. For instance, in earlier versions of the tokenizer, we found entire URLs stored as tokens caused by several documents containing a high number of duplicates. These issues motivated us to remove duplicated lines in the tokenizer training training data. We then applied the same sampling ratios per language as for the training data.

Vocabulary Size A large vocabulary size reduces the risk of over-segmenting some sentences, especially for low-resource languages. We conducted validation experiments using 150k and 250k vocabulary sizes to make comparisons with existing multilingual modeling

literature easier (Conneau et al., 2020; Xue et al., 2021). We ultimately settled for a vocabulary of 250k tokens to reach our initial fertility objective compared to monolingual tokenizers. Since the vocabulary size determines the embedding matrix size, it also had to be divisible by 128 for GPU efficiency reasons and by 4 to be able to use Tensor Parallelism. We used a final size of 250,680 vocabulary items with 200 tokens reserved for possible future applications such as removing private information using placeholder tokens.

Byte-level BPE The tokenizer is a learned subword tokenizer trained using the Byte Pair Encoding (BPE) algorithm introduced by Gage (1994). In order not to lose information during tokenization, the tokenizer creates merges starting from bytes as the smallest units instead of characters (Radford et al., 2019). This way, tokenization never results in unknown tokens because all 256 bytes can be contained in the vocabulary of the tokenizer. In addition, Byte-level BPE maximizes vocabulary sharing between languages (Wang et al., 2020).

Normalization Upstream of the BPE tokenization algorithm, no normalization of the text was performed in order to have the most general model possible. In all cases, we observed that adding unicode normalization such as NFKC did not reduce the fertility by more than 0.8% on all the languages considered but came at the cost of making the model less general; for example, causing 2^2 and 22 to be encoded in the same way.

Pre-tokenizer Our pre-tokenization has two goals: producing a first division of the text (usually using whitespaces and punctuation) and restricting the maximum length of sequences of tokens produced by the BPE algorithm. The pre-tokenization rule used was the following regex: “ `?[^\s|[\.,!?\... , \.]]+`”¹⁸ which splits words apart while preserving all the characters and in particular the sequences of spaces and line breaks that are crucial for programming languages. We do not use English-centric splits common in other tokenizers (e.g. splitting around `'nt` or `'ll`). We also didn't use splits on numbers and digits, which caused issues in Arabic and code.

3.4 Engineering

3.4.1 HARDWARE

The model was trained on Jean Zay,¹⁹ a French government-funded supercomputer owned by GENCI and operated at IDRIS, the national computing center for the French National Center for Scientific Research (CNRS). Training BLOOM took about 3.5 months to complete and consumed 1,082,990 compute hours. Training was conducted on 48 nodes, each having 8 NVIDIA A100 80GB GPUs (a total of 384 GPUs); due to possible hardware failures during training, we also maintained a reserve of 4 spare nodes. The nodes were equipped with 2x AMD EPYC 7543 32-Core CPUs and 512 GB of RAM, while the storage was handled by mix of full flash and hard disk drives using a SpectrumScale (GPFS) parallel file system shared between all nodes and users of the supercomputer. 4 NVLink GPU-to-GPU interconnects per node enabled intra-node communications while 4 Omni-Path 100 Gbps links per node, arranged in an enhanced hypercube 8D global topology, were used for inter-node communications.

¹⁸. github.com/bigscience-workshop/bs-tokenizers

¹⁹. idris.fr/eng/jean-zay/jean-zay-presentation-eng.html

3.4.2 FRAMEWORK

BLOOM was trained using Megatron-DeepSpeed²⁰ (Smith et al., 2022), a framework for large-scale distributed training. It consists of two parts: Megatron-LM²¹ (Shoeybi et al., 2019) provides the Transformer implementation, tensor parallelism, and data loading primitives, whereas DeepSpeed²² (Rasley et al., 2020) provides the ZeRO optimizer, model pipelining, and general distributed training components. This framework allows us to train efficiently with *3D parallelism* (illustrated in Figure 6) — a fusion of three complementary approaches to distributed deep learning. These approaches are described below:

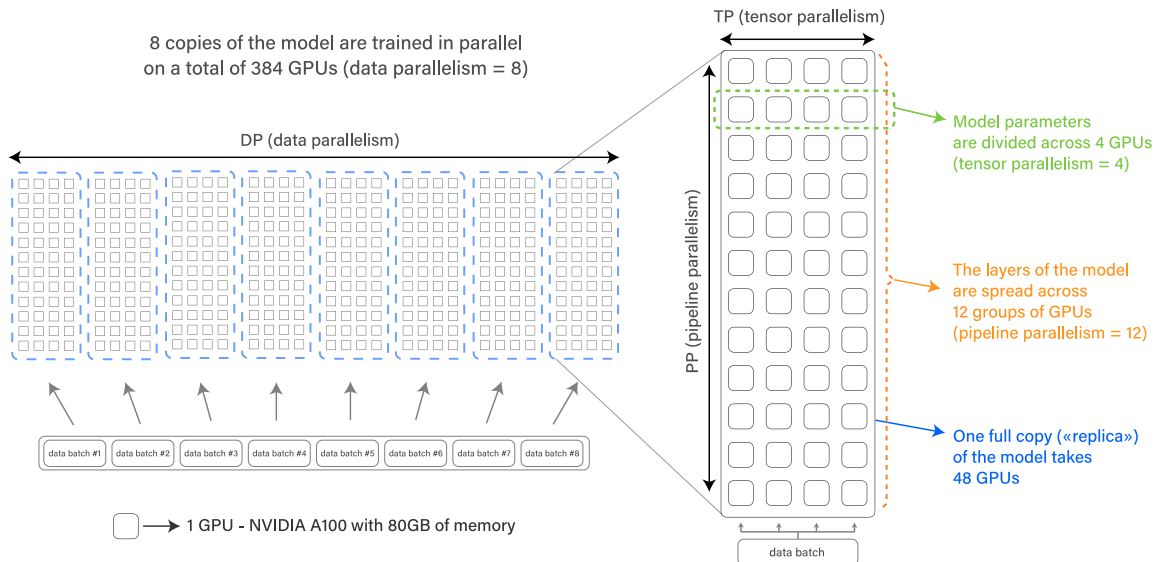

Figure 6: DP+PP+TP combination leads to 3D parallelism.

Data parallelism (DP) replicates the model multiple times, with each replica placed on a different device and fed a slice of the data. The processing is done in parallel and all model replicas are synchronized at the end of each training step.

Tensor parallelism (TP) partitions individual layers of the model across multiple devices. This way, instead of having the whole activation or gradient tensor reside on a single GPU, we place shards of this tensor on separate GPUs. This technique is sometimes called horizontal parallelism or intra-layer model parallelism.

Pipeline parallelism (PP) splits up the model’s layers across multiple GPUs, so that only a fraction of the layers of the model are placed on each GPU. This is sometimes called vertical parallelism.

Finally, the Zero Redundancy Optimizer (ZeRO; Rajbhandari et al., 2020) allows different processes to only hold a fraction of data (parameters, gradients, and optimizer states)

20. github.com/bigscience-workshop/Megatron-DeepSpeed

21. github.com/NVIDIA/Megatron-LM

22. github.com/microsoft/DeepSpeed

required for a training step. We used ZeRO stage 1, meaning that only the optimizer states are sharded in this manner.

The four components described above are combined together to allow scaling to hundreds of GPUs with extremely high GPU utilization. We were able to achieve 156 TFLOPs in our fastest configuration with A100 GPUs, attaining our objective of half of the theoretical peak performance of 312 TFLOPs (in `float32` or `bfloat16`).

3.4.3 FLOATING POINT FORMAT

In earlier experiments with 104B-parameter models on NVIDIA V100 GPUs, we observed numerical instabilities that caused irreversible training divergences. We hypothesize that these instabilities stem from our initial use of IEEE `float16` — a 16-bit floating point format with a very limited dynamic range that can cause overflows. The NVIDIA A100 GPUs that we ultimately had access to support the `bfloat16` format (Wang and Kanwar, 2019; Kalamkar et al., 2019), which has the same dynamic range as `float32`. On the other hand, `bfloat16` still has much lower precision, which motivated our use of mixed-precision training (Micikevicius et al., 2018). This technique performs certain precision-sensitive operations such as gradient accumulation and softmax in `float32` precision and the rest of operations in lower precision, allowing us to achieve a balance of high performance and training stability. Ultimately, we performed final training in `bfloat16` mixed precision, which proved to solve the instability problem (in line with previous observation by Smith et al., 2022).

3.4.4 FUSED CUDA KERNELS

In general, GPUs cannot retrieve data to perform computations on and perform these computations at the same time. Moreover, the compute performance of modern GPUs is much higher than the speed of memory transfer required for every operation (often called a *kernel* in GPU programming). Kernel fusion (Wu et al., 2012) is an approach for optimizing GPU-based computations by performing several consecutive operations in only one kernel call. This approach offers a way to minimize data transfers: intermediary results stay in the GPU register instead of being copied into VRAM, saving overhead.

We used several custom fused CUDA kernels provided by Megatron-LM. First, we used an optimized kernel to perform LayerNorm, as well as kernels to fuse various combinations of the scaling, masking, and softmax operations. The addition of a bias term is also fused with the GeLU activation using the JIT functionality of PyTorch. As an example consequence of the use of fused kernels, adding the bias term in the GeLU operation adds no additional time, as the operation is memory-bound: the additional computation is negligible compared to data transfers between GPU VRAM and registers, so fusing both operations essentially halves their runtime.

3.4.5 ADDITIONAL CHALLENGES

Scaling to 384 GPUs required two final changes: disabling asynchronous CUDA kernel launches (for ease of debugging and to prevent deadlocks) and splitting parameter groups into smaller subgroups (to avoid excessive CPU memory allocations).

BLOOM

During training, we faced issues with hardware failures: on average, 1–2 GPU failures occurred each week. As backup nodes were available and automatically used, and checkpoints were saved every three hours, this did not affect training throughput significantly. A PyTorch deadlock bug in the data loader and disk space issues led to 5–10h downtimes. Given the relative sparsity of engineering issues, and since there was only one loss spike, which the model swiftly recovered from, human intervention was less necessary than in comparable projects (Zhang et al., 2022). Full details of our experience with training BLOOM and a detailed report of all issues we faced are publicly available.²³

3.5 Training

Hyperparameter (↓)	BLOOM-560M	BLOOM-1.1B	BLOOM-1.7B	BLOOM-3B	BLOOM-7.1B	BLOOM
<i>Architecture hyperparameters</i>						
Parameters	559M	1,065M	1,722M	3,003M	7,069M	176,247M
Precision			<code>float16</code>			<code>bfloat16</code>
Layers	24	24	24	30	30	70
Hidden dim.	1024	1536	2048	2560	4096	14336
Attention heads	16	16	16	32	32	112
Vocab size			250,680			250,680
Sequence length			2048			2048
Activation			GELU			GELU
Position emb.			Alibi			Alibi
Tied emb.			True			True
<i>Pretraining hyperparameters</i>						
Global Batch Size	256	256	512	512	512	2048
Learning rate	3.0e-4	2.5e-4	2e-4	1.6e-4	1.2e-4	6e-5
Total tokens			341B			366B
Warmup tokens			375M			375M
Decay tokens			410B			410B
Decay style			<code>cosine</code>			<code>cosine</code>
Min. learning rate			1e-5			6e-6
Adam (β_1, β_2)			(0.9, 0.95)			(0.9, 0.95)
Weight decay			1e-1			1e-1
Gradient clipping			1.0			1.0
<i>Multitask finetuning hyperparameters</i>						
Global Batch Size	1024	1024	2048	2048	2048	2048
Learning rate	2.0e-5	2.0e-5	2.0e-5	2.0e-5	2.0e-5	2.0e-5
Total tokens			13B			13B
Warmup tokens			0			0
Decay style			<code>constant</code>			<code>constant</code>
Weight decay			1e-4			1e-4

Table 3: BLOOM & BLOOMZ Training Hyperparameters.

²³. github.com/bigscience-workshop/bigscience/blob/master/train/tr11-176B-ml/chronicles.md

Pretrained Models We train six size variants of BLOOM with respective hyperparameters detailed in Table 3. Architecture and training hyperparameters come from our experimental results (Le Scao et al., 2022) and prior work on training large language models (Brown et al., 2020; Kaplan et al., 2020). Model depth and width for the non-176B models roughly follow previous literature (Brown et al., 2020; Zhang et al., 2022), deviating for 3B and 7.1B in order only to fit the models more easily on our training setup. Embedding parameter sizes are larger for BLOOM owing to the larger multilingual vocabulary, but scaling literature discounts embedding operations (Kaplan et al., 2020). During the development process at the 104B parameters scale, we experimented with different values of Adam β parameters, weight decay and gradient clipping to target stability, but did not find it helpful. For all models, we use a cosine learning rate decay schedule (Loshchilov and Hutter, 2016) over 410B tokens, taken as an upper bound for the length of training if compute permitted, and warmup for 375M tokens. We use weight decay, gradient clipping, and no dropout. The ROOTS dataset contains around 341 billion tokens of text, so we aimed to train all models for the equivalent amount of tokens. However, in light of revised scaling laws published during training (Hoffmann et al., 2022), we decided to train the large models for an additional 25 billion tokens on repeated data. As warmup tokens + decay tokens were larger than the total number of tokens, the end of learning rate decay was never reached.

Multitask Finetuning Finetuned BLOOMZ models (Muennighoff et al., 2022b) maintain the same architecture hyperparameters as BLOOM models. The finetuning hyperparameters are loosely based on T0 (Sanh et al., 2022) and FLAN (Wei et al., 2021). Learning rates are determined by doubling the minimum learning rate of the respective pretrained model and then rounding. Global batch sizes are multiplied by four for small variants to increase throughput. While the models are finetuned for 13 billion tokens, the best checkpoint is chosen according to a separate validation set. We found performance to plateau after 1 – 6 billion tokens of finetuning.

Contrastive Finetuning We also perform contrastive finetuning of the 1.3 and 7.1 billion parameter BLOOM models using the SGPT Bi-Encoder recipe (Muennighoff, 2022) to train models that produce high-quality text embeddings. We created SGPT-BLOOM-7.1B-msmarco²⁴ geared towards multilingual information retrieval and SGPT-BLOOM-1.7B-nli²⁵ for multilingual semantic textual similarity (STS). However, recent benchmarking has found these models to also generalize to various other embedding tasks, such as bitext mining, reranking or feature extraction for downstream classification (Muennighoff et al., 2022a).

3.5.1 CARBON FOOTPRINT

While most attempts to estimate the carbon footprint of language models have shed light on the emissions produced due to energy consumed during model training (e.g. Patterson et al., 2021; Strubell et al., 2019), other sources of emissions are also important to consider. In our efforts to estimate the carbon emissions of BLOOM, we were inspired by the Life Cycle Assessment (LCA) approach (Klöpffer, 1997) and aimed to consider aspects such as

24. hf.co/bigscience/sgpt-bloom-7b1-msmarco

25. hf.co/bigscience-data/sgpt-bloom-1b7-nli

the emissions of equipment manufacturing, intermediate model training, and deployment. According to our estimates, the carbon emissions from BLOOM training add up to approximately 81 tons of CO₂eq, of which 14% were generated by the equipment manufacturing process (11 tons), 30% by the energy consumed during training (25 tons) and 55% by idle consumption of the equipment and computing cluster used for training (45 tons).

Model name	Number of parameters	Power consumption	CO ₂ eq emissions
GPT-3	175B	1,287 MWh	<i>502 tons</i>
Gopher	280B	<i>1,066 MWh</i>	<i>352 tons</i>
OPT	175B	<i>324 MWh</i>	70 tons
BLOOM	176B	433 MWh	25 tons

Table 4: Comparison of carbon emissions between BLOOM and similar LLMs. Numbers in *italics* have been inferred based on data provided in the papers describing the models.

Comparing the carbon emissions of BLOOM training to other similar models (see Table 4), reveals that while the energy consumption of BLOOM is slightly higher than OPT (Zhang et al., 2022) (433 Mwh compared to OPT’s 324 MWh), its emissions are approximately 2/3 less (25 tons versus 70 tons). This is thanks to the low carbon intensity of the energy grid used for training BLOOM, which emits 57 gCO₂eq/kWh, compared to 231 gCO₂eq/kWh for the grid used for OPT training. Specifically, France’s national energy grid (which is used by Jean Zay) is largely powered by nuclear energy, which is low-carbon compared to grids powered by energy sources such as coal and natural gas. While the sustainability of nuclear energy is debated, it is one of the least carbon-intensive sources of energy that is currently available. Both BLOOM and OPT incurred significantly less carbon emissions than GPT-3 (as reported by (Patterson et al., 2021)), which can be attributed to several factors including more efficient hardware as well as less carbon-intensive energy sources.

We also pursued further exploration of the carbon footprint of (1) the computation carried out on Jean Zay within the scope of the Big Science workshop, and (2) running the BLOOM model API in real time. In terms of the footprint of the totality of the computation, we estimate that the final BLOOM training represents approximately 37% of the overall emissions, with other processes such as intermediate training runs and model evaluation adding up to the other 63%. This is slightly less than the estimate made by the authors of the OPT paper, who stated that the total carbon footprint of their model is roughly 2 times higher due to experimentation, baselines and ablation (Zhang et al., 2022). Our ongoing exploration of the carbon emissions of the BLOOM API have estimated that the real-time deployment of the model on a GCP instance with 16 GPUs running in the `us-central1` region results in approximately 20 kg of CO₂eq emitted per day of deployment (or 0.83 kg per hour). This figure is not representative of all deployment use-cases, and will vary depending on the hardware used as well as the specifics of model implementation (e.g. whether batching is used) and the number of requests the model receives. Further information regarding BLOOM’s carbon footprint can be found in Luccioni et al. (2022).

3.6 Release

Openness has been central to the development of BLOOM and we wanted to ensure it is easily available for the community to use. As such, we worked on producing documentation as a Model Card (Mitchell et al., 2019) and a new license addressing specific goals of the project.

Model Card Following best practices for releasing machine learning models, the BLOOM model has been released along with a detailed Model Card²⁶ (Mitchell et al., 2019) describing its technical specifications, details on training, intended-use, out-of-scope uses as well as the model’s limitations. Participants across working groups worked together to produce the final Model Card and similar cards for each checkpoint. The work was collaborative, primarily composed “live” by thinking through and discussing each section, then further dividing into subsections based on the categorizations and distinctions participants naturally ended up creating throughout discussions.

Licensing Being mindful of the potentially harmful use-cases that BLOOM could enable, we chose to strike a balance between unrestricted open-access and responsible-use by including behavioral-use clauses (Contractor et al., 2022) to limit the application of the model towards potentially harmful use-cases. Such clauses are routinely being included in a growing class of “Responsible AI Licenses (RAIL)”²⁷ that the community has been adopting when releasing their models.²⁸ A distinguishing aspect of the RAIL license developed for BLOOM is that it separates licensing of the “source code” and “model”, as referenced by its trained parameters. It further includes detailed definitions of “use” and “derived works” of the model to ensure that anticipated downstream use by prompting, finetuning, distillation, use of logits and probability distributions are explicitly identified. The license contains 13 behavioral-use restrictions that have been identified based on the intended uses and limitations described in the BLOOM Model Card, as well as the BigScience ethical charter. The license offers the model at no charge and users are free to use the model as long as they comply with the terms (including usage restrictions). The source code for BLOOM has been made available under an Apache 2.0 open source license.

4. Evaluation

Our evaluations focus on zero-shot and few-shot settings. Our goal is to present an accurate picture of how BLOOM compares to existing LLMs in settings that most realistically reflect the way the models are likely to be used in practice. Because of the scale of these models, prompt-based adaptation and few-shot “in-context learning” are currently more common than finetuning. Thus, we report results on a range of tasks and languages in zero-shot (Section 4.2) and one-shot (Section 4.3) prompt-based settings, as well as after multitask finetuning (Section 4.4). For comparison with other models, we first report performance on standard benchmark tasks in a zero-shot setting (Section 4.2). We then compare performance across languages using multilingual summarization (Section 4.3.3) and machine

26. hf.co/bigscience/bloom

27. licenses.ai

28. the-turing-way.netlify.app/reproducible-research/licensing/licensing-ml.html

translation (Section 4.3.2). We also interpret BLOOM’s generalization abilities from the perspective of multilingual probing (Section 4.7).

4.1 Experimental Design

4.1.1 PROMPTS

Based on recent research on the impact of prompting on language model performance, we decided to build a language model evaluation suite that allowed us to vary both the basic task data as well as the prompting that is used to contextualize the task. Our prompts were developed prior to BLOOM’s release, and did not undergo any *a priori* refinement using models. That is, the prompts we use in our evaluation are ones that humans believed were a reasonable way to solicit the desired task behavior from a language model. Our goal for designing prompts in this way is to simulate realistic zero-shot or one-shot results that a new user could expect from BLOOM. This is in contrast to presenting best-case performances that might result from multiple rounds of trial-and-error on prompt design. We choose to report the former because the latter is harder to reproduce systematically, is arguably a less representative picture of how the model works in the average setting, and is not representative of true zero-shot learning where no labeled data is available.

We generate multiple prompts per task using `promptsource` (Bach et al., 2022). We follow the procedure used by Sanh et al. (2022), in which prompt generation is crowd-sourced, and thus we see substantial variety in length and style across prompts. To improve quality and clarity, multiple peer reviews were performed on each prompt for artifacts and consistency.

Table 5 shows examples of the resulting prompts used for the WMT’14 task. We also generate prompts for many tasks that are not included in this paper due to resource constraints. All of our prompts for all tasks (both those analyzed in the paper and those not yet analyzed) are publicly available.²⁹

Prompt name	Prompt	Target
a_good_translation	Given the following source text: [source sentence] , a good L2 translation is:	[target sentence]
gpt3	What is the L2 translation of the sentence: [source sentence]?	[target sentence]
version	if the L1 version says [source sentence] then the L2 version should say:	[target sentence]
xglm	L1: [source sentence] = L2:	[target sentence]

Table 5: Four prompts for the WMT’14 dataset (Bojar et al., 2014) for MT evaluation. Above, “L1” and “L2” are replaced with language names (e.g. “Bengali” and “Russian”).

4.1.2 INFRASTRUCTURE

Our framework extends EleutherAI’s Language Model Evaluation Harness (Gao et al., 2021) by integrating it with the `promptsource` (Bach et al., 2022) library described in Section 3.1.4. We release our Prompted Language Model Evaluation Harness as an open source library for people to use. We use this framework in order to run the experiments and aggregate results.

²⁹. github.com/bigscience-workshop/promptsource/tree/eval-hackathon

4.1.3 DATASETS

SuperGLUE We use a subset of the SuperGLUE (Wang et al., 2019) evaluation suite of classification tasks, specifically: Ax-b, Ax-g, BoolQ, CB, WiC, WSC, and RTE tasks. We excluded the remaining tasks because they require an order of magnitude more compute to run than all of these tasks we consider combined. These tasks are English-only, and are thus included to facilitate comparison with prior work, which has primarily focused on English-only models. We also note that performance on these tasks has not yet been widely reported using zero- and one-shot prompt-based setting. T0 (Sanh et al., 2022) is the first exception, but that model is instruction-tuned and thus not directly comparable to models like BLOOM and OPT. For each task, we select a random sample of five prompts from `promptsources` and evaluate all models on that set of prompts. As with other prompting tasks in Evaluation Harness (Gao et al., 2021), the prediction of a model for a given prompt is measured using the maximum log likelihood among a set of specified candidate label strings associated with the prompt.

Machine Translation (MT) We evaluate BLOOM on three datasets (using ISO-639-2 codes to refer to languages): WMT14 eng↔fre and eng↔hin (Bojar et al., 2014), Flores-101 (Goyal et al., 2022) and DiaBLa (Bawden et al., 2020). We evaluate using the `sacrebleu` (Post, 2018) implementation of BLEU (Papineni et al., 2002), using default tokenisation for WMT and DiaBLa and `spm-flores-101` for Flores.³⁰ We use greedy decoding with generation proceeding until the EOS token, or additionally `\n###\n` for the 1-shot case. The maximum generation length was set per dataset to be in line with what is typically used in the literature; specifically, 64 tokens for WikiLingua, WMT14 and 512 tokens for Flores-101 and DiaBLa. Task-specific experimental design details are below.

Summarization We evaluate summarization on the WikiLingua (Ladhak et al., 2020) dataset. WikiLingua is a multilingual summarization dataset comprising WikiHow article and step-by-step summary pairs. Pairs are aligned across multiple languages, with translation of source and summary further reviewed by an international translation team. One-shot conditional natural language generation has typically not been reported by models with size comparable to BLOOM. PaLM (Chowdhery et al., 2022) is the first exception, and reports scores on WikiLingua; however, only the model’s ability to summarize in English was examined (-> en). By contrast, we opted to test BLOOM’s inherent multilingual ability by assessing the abstractive summarization in the source language (e.g. vi -> vi). We focus on the nine languages (Arabic, English, Spanish, French, Hindi, Indonesian, Portuguese, Vietnamese and Chinese) which were amongst those targeted as part of the BigScience effort.

Natural language generation is notoriously challenging to evaluate, with multilingual generation compounding this challenge due to a lack of metric support. Following the suggestions by Gehrmann et al. (2022b), we report ROUGE-2, ROUGE-L (Lin, 2004),³¹ and Levenshtein distance. One important modification to ROUGE is using the SentencePiece tokenizer (Kudo and Richardson, 2018) built from the Flores-101 dataset (Goyal et al.,

30. BLEU+case:mixed+numrefs.1+smooth.exp+{13a,tok:spm-flores}+version:2.2.1

31. For ROUGE, we used the Python implementation at github.com/google-research/google-research/rouge, commit f935042.

2022). A naive approach would use a tokenizer based on English, but using a multilingual tokenizer improves the capacity to measure the fidelity of multilingual generations. To minimize inference time of the model we use the subsamples from the updated GEM benchmark (Gehrmann et al., 2022a) (3000 uniformly sampled test examples). The authors note that there is minimal difference when comparing model performance between the subsamples and the full test sets. For decoding and generation, we use the same procedure as described above for Machine Translation.

4.1.4 BASELINE MODELS

We use the following baseline models where appropriate (e.g. in settings where they support the language of the evaluation dataset):

- mGPT (Shliazhko et al., 2022), GPT-style models trained on 60 languages from Wikipedia and Common Crawl
- GPT-Neo (Black et al., 2021), GPT-J-6B (Wang and Komatsuzaki, 2021), and GPT-NeoX (Black et al., 2022), a family of GPT-style models trained on The Pile (Gao et al., 2020)
- T0 (Sanh et al., 2022), a variant of T5 (Raffel et al., 2020) that underwent multitask prompted finetuning on datasets from P3 (Bach et al., 2022)
- OPT (Zhang et al., 2022), a family of GPT-style model trained on a mixture of datasets including those from RoBERTa Liu et al. (2019) and The Pile (Gao et al., 2020)
- XGLM (Lin et al., 2021), a GPT-style multilingual model trained on a variant of CC100 (Conneau et al., 2020)
- M2M (Fan et al., 2021), a massively multilingual model trained to translate between 100 languages
- AlexaTM (Soltan et al., 2022), an encoder-decoder model trained on a mixture of masked and causal language modeling on data from Wikipedia and mC4 (Xue et al., 2021)
- mTk-Instruct (Wang et al., 2022b), a variant of T5 that underwent multitask prompted finetuning on datasets from Super-NaturalInstructions
- Codex (Chen et al., 2021), a family of GPT models finetuned on code from GitHub
- GPT-fr (Simoulin and Crabbé, 2021), a GPT-style model trained on French text

4.2 Zero-Shot Performance

Across natural language understanding and generation tasks, we find the zero-shot performance of the pretrained models to be near random chance. Figure 7 shows models’ zero-shot performance, on average, across a range of prompts for a range of tasks from the SuperGLUE benchmark. Tables 6 and 7 show zero-shot machine translation results on

English-French and English-Hindi for multiple models and datasets. We do not report zero-shot performance on summarization because generation experiments are expensive to run and, based on the results reported here and initial experiments on zero-shot summarization, it was clear the performance on summarization would be very poor. In all cases, zero-shot performance of models trained on standard language model is near chance.

4.2.1 SUPERGLUE

On SuperGLUE, while some individual prompts show performance improvements by margins as high as 10 accuracy points, the average performance across prompts always hovers around chance, suggesting that the success of individual prompts is primarily statistical variation. The exception is the T0 model, which shows strong performance. However, this model is finetuned in the multitask setting (similar to BLOOMZ, see Section 4.4) in order to improve performance in zero-shot prompting settings, and thus is not directly comparable to the other models shown here.



Figure 7: Performance of various LLMs on subset of tasks from SuperGLUE benchmark in zero- and one-shot prompt-based setting.

4.2.2 MACHINE TRANSLATION

In the zero-shot setting, MT results are generally very poor, as illustrated by Table 6, which gives averaged scores for different prompts and multiple runs. The multiple runs are carried out across different BLOOM versions (of different sizes). The scores vary across different runs (e.g. 0.32–21.96 for the “version” prompt), and somewhat surprisingly the best prompts tend to be the more verbose ones (“version” and “a_good_translation” prompts).

The two major problems observed are (i) over-generation and (ii) not producing the correct language (an obvious prerequisite for a good translation). These same problems can be seen with other LMs, as can be shown by the generally poor results on the DiaBla

Prompt	eng→fre		fre→eng		eng→hin		hin→eng	
a_good_translation	3.79	(0.40–15.38)	11.05	(5.11–16.81)	0.54	0.06–1.90	6.21	(0.88–13.04)
gpt3	1.72	(0.46–7.90)	5.16	(0.53–12.73)	0.10	(0.03–0.26)	0.27	(0.00–0.66)
version	5.19	(0.32–21.96)	13.45	(3.87–26.79)	0.82	(0.08–1.96)	7.57	(1.74–11.48)
xglm	1.55	(0.24–4.16)	6.49	(2.65–11.23)	0.25	(0.02–0.63)	1.75	(0.22–4.10)

Table 6: WMT’14 zero-shot results (average BLEU and ranges for multiple runs carried out on different BLOOM versions, corresponding to different sizes of models). The prompts used are described in Table 5.

Prompt	eng→fre			fre→eng		
	T0	mGPT	BLOOM	T0	mGPT	BLOOM
MT sent-level	0.33	0.09	0.05	12.53	0.27	0.11
MT complete (1-orig-context)	0.87	0.13	1.08	13.77	0.59	1.31

Table 7: Comparison of zero-shot results for DiaBLA against baseline LMs. The “MT sent-level” prompt requests for a translation given the source language only, whereas the “MT complete (1-orig-context)” prompt asks to complete a translation given the previous and current source sentences and the beginning of the translation, i.e. the previous sentence in the target language.

dataset shown in Table 7. Despite not being a multilingual model, T0 (Sanh et al., 2022) can sometimes perform translation into English (12.53 and 13.77 BLEU), though the fact that it is an English-based model may explain why it performs better. For BLOOM, the “wrong-language” problem is partially alleviated in the into-English directions by using prompts that end in the target language (as opposed to ending with the source text to translate), presumably because it is easier to generate a continuation of the prompt in the same language.

4.3 One-Shot Results

In the one-shot evaluation—where models are given a single in-context training example—we find that performance generally improves for generation tasks (MT and summarization), but not for the SuperGLUE classification tasks.

4.3.1 SUPERGLUE

Figure 7 shows one-shot performance alongside the zero-shot results. As compared to zero-shot performance, one-shot performance variability to SuperGLUE is reduced across all prompts and models. Overall, there is no notable improvement associated with the one-shot setting: models average accuracy is still nearly always at chance (with the exception of T0).

We perform an additional analysis comparing BLOOM models across model sizes. As a baseline, we also measure the average one-shot accuracy of OPT models of similar sizes

(350M parameters to 175B parameters).³² Figure 8 shows the accuracy of each prompt on each task across model scales. Both OPT and BLOOM model families improve slightly with scale, and there is no consistent difference between families across all tasks. BLOOM-176B is ahead of OPT-175B on Ax-b, CB and WiC.

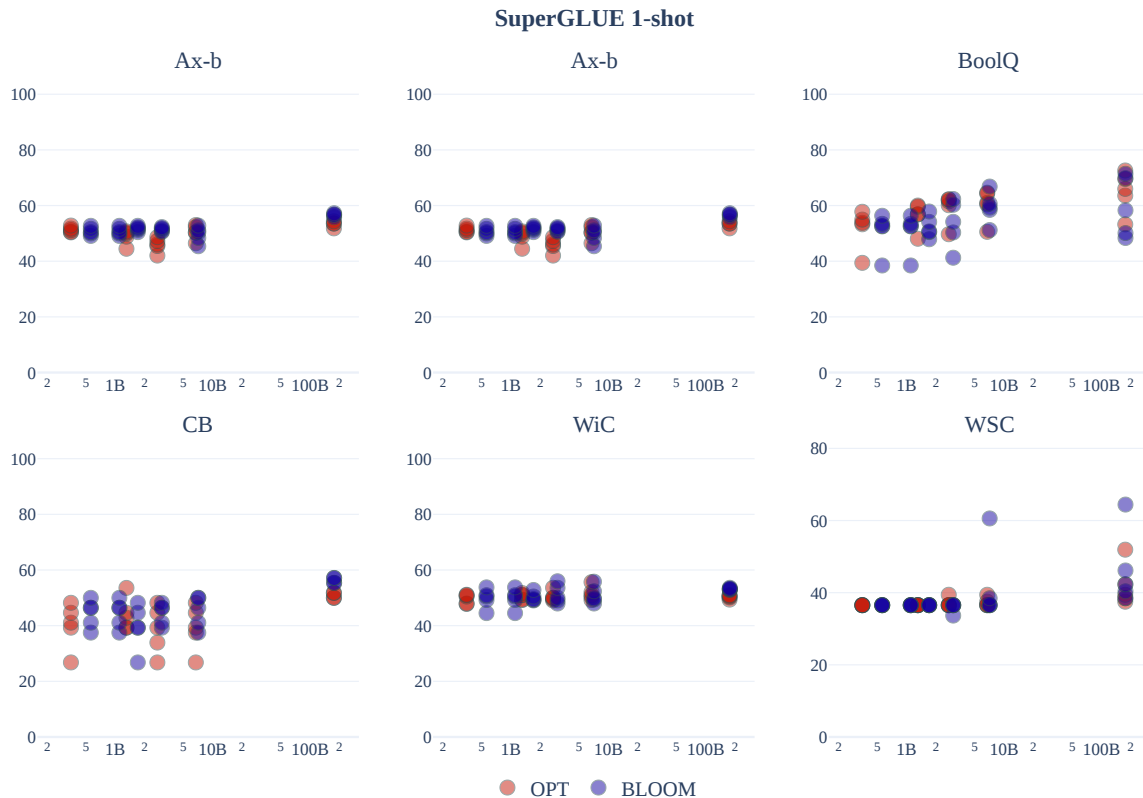

Figure 8: Comparison of the scaling of BLOOM versus OPT on each SuperGLUE one-shot task. Each point represents the average accuracy of a model within the BLOOM or OPT family of models on one of the five task prompts. The number of parameters on the x-axis is presented in log-scale.

4.3.2 MACHINE TRANSLATION

In the 1-shot setting, we test several language directions in the Flores-101 (Goyal et al., 2022) devtest set using the XGLM prompt (Lin et al., 2021). We choose the 1-shot example randomly from the same dataset, which may differ from past work. We separate out results for high-resource language pairs (table 8c), high-to-mid-resource language pairs (table 8d), low-resource language pairs (table 8a) and between related languages of the Romance language family (table 8b). Languages are classified as low-, mid- and high-resource depending on their representation in ROOTS. For high- and mid-to-high-resource pairs,

³². We do not evaluate OPT-66B because of the lack of a similarly-sized BLOOM model.

we compare to supervised results from the M2M-124 model (Fan et al., 2021) with 615M parameters, for which scores are computed by Goyal et al. (2022). Additionally, we compare to XGLM (7.5B) 1-shot results (Lin et al., 2021) and 32-shot AlexaTM results (Soltan et al., 2022). Results are good across the board for both translation between high-resource languages and from high- to mid-resource languages, suggesting BLOOM’s good multilingual capacity, even across scripts (here between Latin (or extended Latin), Chinese, Arabic and Devanagari scripts). Comparing against the supervised M2M model, results are often comparable and sometimes better in this 1-shot setting, and results are comparable in many cases to those of AlexaTM.

The translation quality for many of the low-resource languages is good, comparable or even slightly better than the supervised M2M model. However, results are very poor between Swahili and Yoruba, languages that are present but under-represented in BLOOM’s training data (<50k tokens each). This contrasts with the results for translation between Romance (and therefore related) languages, where results are good across-the-board, including for translation from Galician (glg), a language not included in the training data, but which shares many similarities with the other Romance languages, in particular with Portuguese (por). This however does question BLOOM’s quality on those under-represented low-resource languages included in training.

4.3.3 SUMMARIZATION

Figure 9 shows one-shot results for BLOOM models alongside OPT-175B for comparison. Each point represents a per-prompt score. The key takeaways are that BLOOM attains higher performance on multilingual summarization than OPT and that performance increases as the parameter count of the model increases. We suspect this is due to BLOOM’s multilingual-focused training.

As discussed in Section 4.1, we report ROUGE-2 scores for the sake of comparability with prior work, and because there is a lack of alternatives for generation evaluation. However, we qualitatively observe that in many cases, the ROUGE-2 score understates the quality of the summaries generated by the systems.

4.4 Multitask Finetuning

Building on recent work on multitask finetuning (Sanh et al., 2022; Wei et al., 2021; Wang et al., 2022a) we explore using *multilingual* multitask finetuning to improve the zero-shot performance of the BLOOM model. We conducted multilingual multitask finetuning of BLOOM models using the xP3 corpus outlined in Section 3.1.4. We find that zero-shot performance significantly increases. In Figure 10, we compare the zero-shot performance of pretrained BLOOM and XGLM models with multitask finetuned BLOOMZ, T0 and mTk-Instruct (Wang et al., 2022b). BLOOM and XGLM performances are near the random baselines of 33% for NLI (XNLI) and 50% for coreference resolution (XWinograd) and sentence completion (XCOPA and XStoryCloze). After going through multilingual multitask finetuning (BLOOMZ), zero-shot performance significantly improves on the depicted held-out tasks. Despite also being multitask finetuned, T0 performs badly on the multilingual datasets shown due to it being a monolingual English model. Additional results provided in Muennighoff et al. (2022b), however, show that models finetuned on xP3 also

Src↓	Trg→	eng	ben	hin	swh	yor
eng	M2M	–	23.04	28.15	29.65	2.17
	BLOOM	–	25.52	27.57	21.7	2.8
ben	M2M	22.86	–	21.76	14.88	0.54
	BLOOM	30.23	–	16.4	–	–
hin	M2M	27.89	21.77	–	16.8	0.61
	BLOOM	35.40	23.0	–	–	–
swh	M2M	30.43	16.43	19.19	–	1.29
	BLOOM	37.9	–	–	–	1.43
yor	M2M	4.18	1.27	1.94	1.93	–
	BLOOM	3.8	–	–	0.84	–

(a) Low-resource languages

Src↓	Trg→	cat	spa	fre	por
cat	M2M	–	25.17	35.08	35.15
	BLOOM	–	29.12	34.89	36.11
spa	M2M	23.12	–	29.33	28.1
	BLOOM	31.82	–	24.48	28.0
glg	M2M	30.07	27.65	37.06	34.81
	BLOOM	38.21	27.24	36.21	34.59
fre	M2M	28.74	25.6	–	37.84
	BLOOM	38.13	27.40	–	39.60
por	M2M	30.68	25.88	40.17	–
	BLOOM	40.02	28.1	40.55	–

(b) Romance languages

Src ↓	Trg →	ara	fre	eng	chi	spa
ara	M2M	–	25.7	25.5	13.1	16.74
	XGLM	–	17.9	27.7	–	–
	AlexaTM	–	35.5	41.8	–	23.2
	BLOOM	–	33.26	40.59	18.88	23.33
fre	M2M	15.4	–	37.2	17.61	25.6
	XGLM	5.9	–	40.4	–	–
	AlexaTM	24.7	–	47.1	–	26.3
	BLOOM	23.30	–	45.11	22.8	27.4
eng	M2M	17.9	42.0	–	19.33	25.6
	XGLM	11.5	36.0	–	–	–
	AlexaTM	32.0	50.7	–	–	31.0
	BLOOM	28.54	44.4	–	27.29	30.1
chi	M2M	11.55	24.32	20.91	–	15.92
	XGLM	–	–	–	–	–
	AlexaTM	–	–	–	–	–
	BLOOM	15.58	25.9	30.60	–	20.78
spa	M2M	12.1	29.3	25.1	14.86	–
	XGLM	–	–	–	–	–
	AlexaTM	20.8	33.4	34.6	??	–
	BLOOM	18.69	24.48	33.63	20.06	–

(c) High-resource language pairs.

Src ↓	Trg →	eng	fre	hin	ind	vie
eng	M2M	–	41.99	28.15	37.26	35.1
	BLOOM	–	44.4	27.57	38.75	28.83
fre	M2M	37.17	–	22.91	29.14	30.26
	BLOOM	45.11	–	17.04	29.50	31.66
hin	M2M	27.89	25.88	–	21.03	23.85
	BLOOM	35.40	27.83	–	–	–
ind	M2M	33.74	30.81	22.18	–	31.4
	BLOOM	44.59	29.75	–	–	–
vie	M2M	29.51	28.52	20.35	27.1	–
	BLOOM	38.77	28.57	–	–	–

(d) High→mid-resource language pairs.

Table 8: 1-shot MT results (spBLEU) on the Flores-101 devtest set.

outperform T0 on English datasets when controlling for size and architecture. This is likely due to T0’s finetuning dataset (P3) containing less diverse datasets and prompts than xP3. Multitask finetuning performance has been shown to correlate with the amount of datasets and prompts (Chung et al., 2022).

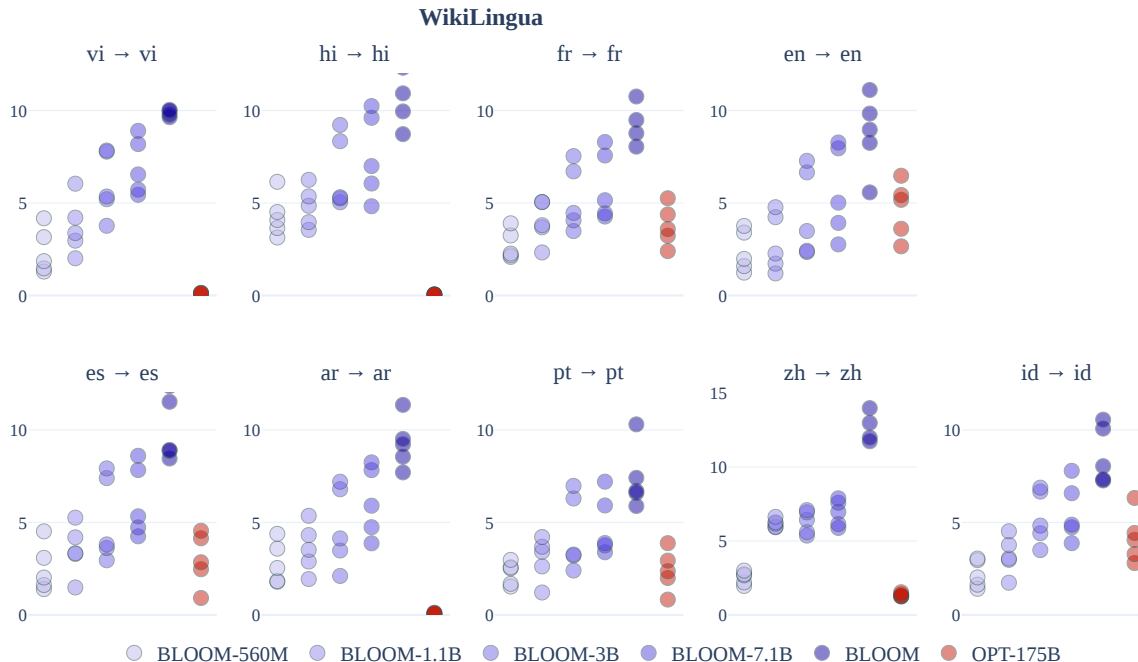

Figure 9: WikiLingua One-shot Results. Each plot represents a different language with per-prompt ROUGE-2 F-measure scores.

4.5 Code Generation

The BLOOM pretraining corpus, ROOTS, consists of around 11% of code. In Table 9, we report benchmarking results of BLOOM on HumanEval (Chen et al., 2021). We find the performance of pretrained BLOOM models to be similar to that of the similar-sized GPT models trained on the Pile (Gao et al., 2020). The Pile contains English data and around 13% of code (GitHub + StackExchange), which is similar to the code data sources and proportions in ROOTS. The Codex models, which have solely been finetuned on code, are significantly stronger than other models. Multitask finetuned BLOOMZ models do not improve significantly over BLOOM models. We hypothesize this is due to the finetuning dataset, xP3, not containing significant amounts of pure code completion. Rather, xP3 contains code-related tasks, such as estimating the time complexity of a given Python code snippet. Additional analysis is provided in Muennighoff et al. (2022b).

4.6 Embeddings

In Section 3.5, we have outlined the contrastive finetuning procedure for creating SGPT-BLOOM text embedding models. In Table 10, we report benchmarking results on two multilingual datasets from the Massive Text Embedding Benchmark (MTEB, Muennighoff et al., 2022a). We find that SGPT-BLOOM-7.1B-msmarco³⁵ provides state-of-the-art per-

³⁵hf.co/bigscience/sgpt-bloom-7b1-msmarco

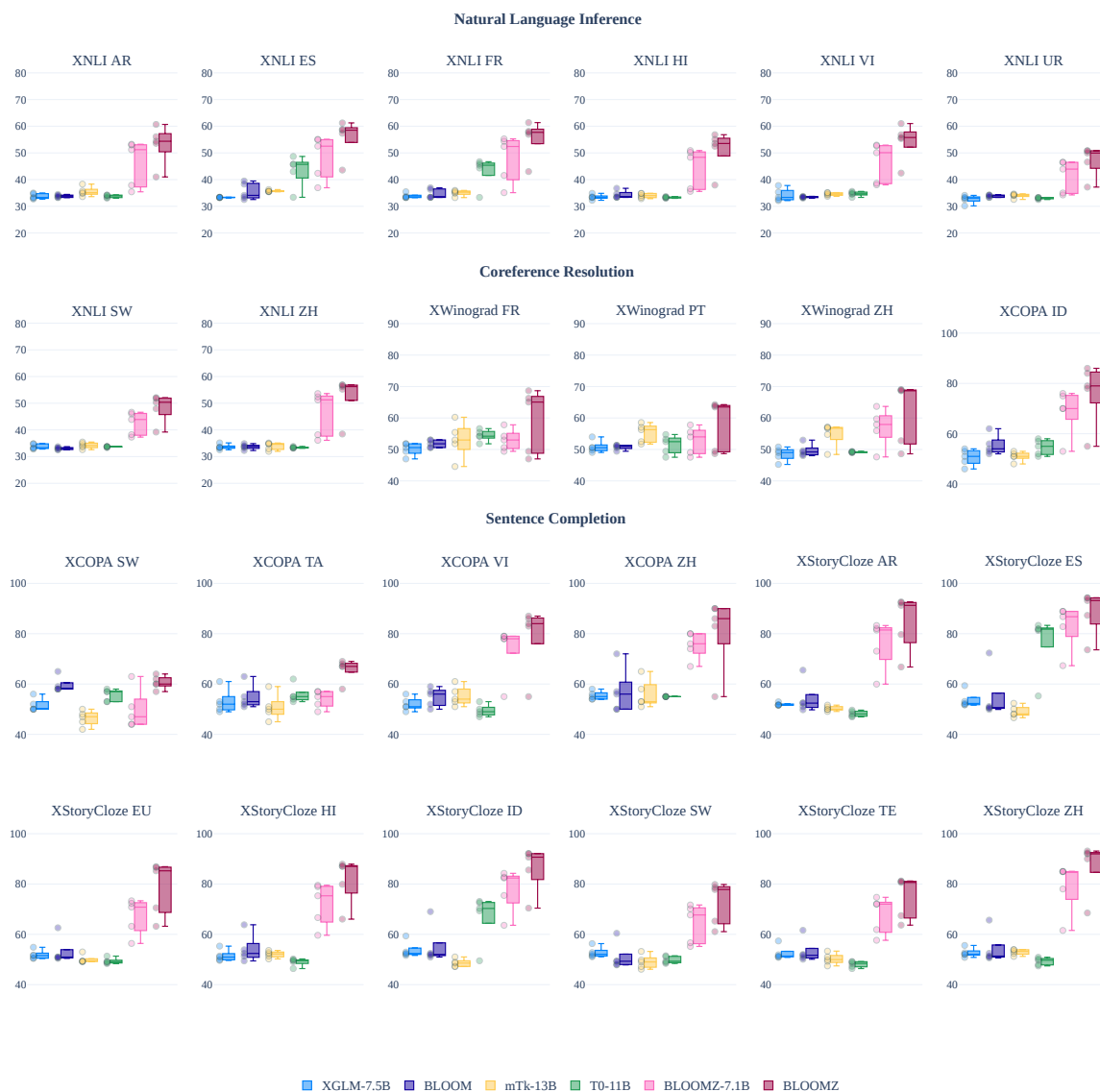

Figure 10: BLOOMZ zero-shot task generalization. Five untuned prompts are evaluated for each dataset and plotted. T0 is monolingual (English) while other models are multilingual. T0 performance may be hurt by its inability to tokenize some non-English texts.

formance on several classification and semantic textual similarity splits. However, with 7.1 billion parameters it is an order of magnitude larger than models like the displayed multilingual MiniLM³⁶ and MPNet³⁷. SGPT-BLOOM-1.7B-nli³⁸ performs significantly worse, likely due to less parameters and its finetuning being shorter (NLI is a much smaller dataset

36. hf.co/sentence-transformers/paraphrase-multilingual-MiniLM-L12-v2

37. hf.co/sentence-transformers/paraphrase-multilingual-mpnet-base-v2

38. hf.co/bigscience/sgpt-bloom-1b7-nli

BLOOM

	PASS@ k		
	$k = 1$	$k = 10$	$k = 100$
GPT-NEO 1.3B	4.79%	7.47%	16.30%
GPT-NEO 2.7B	6.41%	11.27%	21.37%
GPT-J 6B	11.62%	15.74%	27.74%
GPT-NEOX 20B	15.4%	25.6%	41.2%
CODEX-300M	13.17%	20.37%	36.27%
CODEX-679M	16.22%	25.7%	40.95%
CODEX-2.5B	21.36%	35.42%	59.5%
CODEX-12B	28.81%	46.81%	72.31%
BLOOM-560M	0.82%	3.02%	5.91%
BLOOM-1.1B	2.48%	5.93%	9.62%
BLOOM-1.7B	4.03%	7.45%	12.75%
BLOOM-3B	6.48%	11.35%	20.43%
BLOOM-7.1B	7.73%	17.38%	29.47%
BLOOM	15.52%	32.20%	55.45%
BLOOMZ-560M	2.18 %	4.11%	9.00%
BLOOMZ-1.1B	2.63%	6.22%	11.68%
BLOOMZ-1.7B	4.38%	8.73%	16.09%
BLOOMZ-3B	6.29%	11.94%	19.06%
BLOOMZ-7.1B	8.06%	15.03%	27.49%
BLOOMZ	12.06%	26.53%	48.44%

Table 9: Performance on HumanEval (Chen et al., 2021). Non-BLOOM results come from prior work (Chen et al., 2021; Fried et al., 2022). The Codex model is a language model that was finetuned on code, while the GPT models (Black et al., 2021; Wang and Komatsuzaki, 2021; Black et al., 2022) are trained on a mix of code and text like BLOOM.

than MS-MARCO). Apart from the BLOOM models, ST5-XL³⁹ is the largest model with 1.2 billion parameters. However, as an English-only model its performance on non-English languages is poor. The languages displayed are part of the BLOOM pretraining corpus. Performance on more languages and datasets can be inspected on the MTEB leaderboard⁴⁰.

4.7 Multilingual Probing

Probing has emerged as a significant evaluation paradigm to analyze and interpret the inner workings of LLMs (Ettinger et al., 2016; Adi et al., 2017; Belinkov et al., 2017; Hupkes et al., 2018; Tenney et al., 2018; Belinkov and Glass, 2019; Teehan et al., 2022), although it comes with certain shortcomings (Belinkov, 2022). Examination of the LLM embeddings can help

39. [hf.co/sentence-transformers/sentence-t5-xl](https://huggingface.co/sentence-transformers/sentence-t5-xl)

40. [hf.co/spaces/mteb/leaderboard](https://huggingface.co/spaces/mteb/leaderboard)

	ST5-XL	LASER2	MiniLM-L12 ³³	MPNet ³⁴	LaBSE	SGPT-BLOOM-1.7B	SGPT-BLOOM-7.1B
<i>Embedding classification performance on MASSIVE (FitzGerald et al., 2022) scored using accuracy</i>							
Arabic (ar)	4.18	37.16	51.43	45.14	50.86	54.59	59.25
Bengali (bn)	2.60	42.51	48.79	35.34	58.22	57.76	61.59
English (en)	72.09	47.91	69.32	66.84	61.46	66.69	69.67
Spanish (es)	57.97	45.44	64.43	59.66	58.32	61.77	66.35
French (fr)	60.99	46.13	64.82	60.25	60.47	64.58	66.95
Hindi (hi)	3.02	40.20	62.77	58.37	59.40	60.74	63.54
Indonesian (id)	41.53	45.81	65.43	59.85	61.12	60.07	64.06
Kannada (kn)	2.79	4.32	50.63	40.98	56.24	48.56	53.54
Malayalam (ml)	2.98	41.33	54.34	42.41	57.91	55.10	58.27
Portuguese (pt)	57.95	48.55	64.89	61.27	60.16	62.52	66.69
Swahili (sw)	30.60	31.89	31.95	29.57	51.62	43.90	49.81
Tamil (ta)	1.79	29.63	50.17	36.77	55.04	52.66	56.40
Telugu (te)	2.26	36.03	52.82	40.72	58.32	49.32	54.71
Urdu (ur)	2.70	26.11	56.37	52.80	56.70	51.00	56.75
Vietnamese (vi)	21.47	44.33	59.68	56.61	56.67	59.85	64.53
<i>Semantic textual similarity on STS22 (Madabushi et al., 2022) scored using spearman correlation of cosine similarities</i>							
Arabic (ar)	29.60	42.57	52.19	46.20	57.67	48.64	58.67
English (en)	64.32	39.76	63.06	61.72	60.97	61.45	66.13
Spanish (es)	58.16	54.92	59.91	56.56	63.18	61.81	65.41
French (fr)	77.49	58.61	74.30	70.55	77.95	73.18	80.38
Chinese (zh)	33.55	49.41	61.75	58.75	63.02	58.53	66.78

Table 10: Performance of BLOOM models finetuned for sentence embeddings on classification and STS datasets from MTEB (Muennighoff et al., 2022b).

shed light on the generalizing abilities of the model apart from its training objective loss or downstream task evaluation, which is especially beneficial for examining languages lacking annotated datasets or benchmarks.

4.7.1 METHOD

For interpreting BLOOM’s multilingual generalizing abilities, we utilize the “Universal Probing” framework⁴¹ for systematic probing analysis in 104 languages and 80 morphosyntactic features (Serikov et al., 2022). The framework provides SentEval-style (Conneau et al., 2018) probing setup and datasets for each language available in Universal Dependencies (UD; Nivre et al., 2016). We consider the following 17 languages from 7 language families present in BLOOM’s pretraining corpus (Section 3.1) and UD treebanks: Arabic (Afro-Asiatic), Bambara (Mande), Basque (language isolate), Bengali, Catalan, English, French, Hindi, Marathi, Portuguese, Spanish, Urdu (Indo-European), Chinese (Sino-Tibetan), Indonesian (Austronesian), Tamil (Dravidian), Wolof, Yoruba (Niger-Congo). Our setup covers 38 morphosyntactic features in total, which represent language-specific linguistic information. We provide a dataset sample in Table 11.

The probing procedure is conducted as follows. First, we compute <s>-pooled representations of the input sentence at each layer of the 1.7B-parameter BLOOM variant (“BLOOM 1B7”) and BLOOM (with 176B parameters). Second, we train a binary logistic regression classifier to predict a presence of a morphosyntactic feature in the sentence.

41. github.com/bigscience-workshop/massive-probing-framework

Language	Label	Sentence
English	Sing	The scheme makes money through sponsorship and advertising .
	Plur	Still , there are questions left unanswered .
Spanish	Sing	Eligio no ir tras un tercer período en el siguiente ciclo de elecciones .
	Plur	Todavía quedan preguntas sin responder .

Table 11: Examples of the Number task in English and Spanish. The subject number indicator is highlighted in **bold**. The task is to predict if the sentence includes a singular subject number (upper sentence) and a plural subject number (bottom sentence).

Logistic regression is chosen due to its higher selectivity as opposed to non-linear probing classifiers (Hewitt and Liang, 2019). We use the original UD training, validation, and test splits here. Third, the probing performance is evaluated by F_1 weighted score due to target class imbalance for most probing tasks. The results are averaged across three runs with different random seeds.

Baselines We compare the probing performance with random guessing and logistic regression classifiers trained on the following TF-IDF features (Salton and Yang, 1973): word unigrams, character N-grams, BPE⁴² token N-grams, and SentencePiece⁴³ (SP; Kudo and Richardson, 2018) token N-grams. We use the N-gram range $\in [1; 4]$ and limit the TF-IDF vocabularies to top-250k features.

Correlation We run statistical tests to analyze correlations between the probing performance and linguistic, dataset, and model configuration criteria:

- Language script: the results are divided into two groups by the language script – Latin and others (Devanagari, Tamil, and Arabic). Here, we use the non-parametric test Mann-Whitney U (Mann and Whitney, 1947).
- Language family: the results are divided into 7 groups by the language family. We apply the ANOVA to analyze the variance between the groups.
- Probing and pretraining dataset size: we run the Pearson correlation coefficient test (Pearson, 1895) to compute correlation between the probing performance and these data configuration criteria.
- Effect of the model size: the results are divided into two groups by the BLOOM version. Here, we use the Mann-Whitney U test to see if there is a correlation between the number of parameters and the probing results.

4.8 Results

Probing Table 12 presents the results of probing experiments averaged over the probing tasks and experiment runs within each language. The overall pattern is that BLOOM-1B7 performs on par or better than BLOOM, and both LLMs outperform the count-based

42. BertTokenizer: [hf.co/bert-base-multilingual-cased](https://huggingface.co/bert-base-multilingual-cased)

43. XLMRobertaTokenizer: [hf.co/xlm-roberta-base](https://huggingface.co/xlm-roberta-base)

baselines. In particular, the LLMs achieve more robust performance on Arabic, Basque, and Indo-European languages (e.g., Catalan, French, Hindi, Portuguese, Spanish, and Urdu), while Bengali, Wolof, and Yoruba receive the lowest scores. We attribute this behavior to the transfer abilities: BLOOM infers linguistic properties better for the closely related languages that comprise a significant amount of data. For example, the performance on any Romance language is better than in English, and the results in Indic languages are close to those in high-resource languages.

	BLOOM-1B7	BLOOM	Random	TF-IDF (Char)	TF-IDF (Word)	TF-IDF (BPE)	TF-IDF (SP)
Arabic	0.66 ± 0.27	0.64 ± 0.27	0.49 ± 0.013	0.41 ± 0.44	0.4 ± 0.44	0.41 ± 0.44	0.41 ± 0.44
Bambara	0.64 ± 0.16	0.59 ± 0.16	0.45 ± 0.1	0.52 ± 0.46	0.45 ± 0.47	0.48 ± 0.49	0.49 ± 0.49
Basque	0.68 ± 0.19	0.62 ± 0.19	0.49 ± 0.03	0.41 ± 0.43	0.44 ± 0.46	0.48 ± 0.44	0.41 ± 0.46
Bengali	0.42 ± 0.15	0.45 ± 0.12	0.35 ± 0.23	0.63 ± 0.48	0.37 ± 0.44	0.41 ± 0.32	0.76 ± 0.28
Catalan	0.65 ± 0.25	0.61 ± 0.26	0.34 ± 0.01	0.24 ± 0.38	0.24 ± 0.39	0.24 ± 0.39	0.24 ± 0.39
Chinese	0.66 ± 0.25	0.50 ± 0.21	0.55 ± 0.03	0.03 ± 0.05	0.11 ± 0.28	0.04 ± 0.06	0.03 ± 0.05
English	0.57 ± 0.24	0.57 ± 0.24	0.43 ± 0.03	0.45 ± 0.43	0.46 ± 0.43	0.45 ± 0.43	0.44 ± 0.44
French	0.61 ± 0.23	0.57 ± 0.22	0.44 ± 0.02	0.32 ± 0.43	0.32 ± 0.43	0.32 ± 0.43	0.33 ± 0.44
Hindi	0.63 ± 0.23	0.6 ± 0.25	0.48 ± 0.03	0.53 ± 0.46	0.55 ± 0.47	0.53 ± 0.46	0.53 ± 0.46
Indonesian	0.65 ± 0.27	0.6 ± 0.27	0.48 ± 0.05	0.41 ± 0.46	0.43 ± 0.45	0.41 ± 0.46	0.45 ± 0.45
Marathi	0.57 ± 0.25	0.48 ± 0.24	0.32 ± 0.09	0.44 ± 0.47	0.46 ± 0.46	0.44 ± 0.47	0.44 ± 0.47
Portugese	0.67 ± 0.23	0.63 ± 0.26	0.4 ± 0.03	0.48 ± 0.48	0.49 ± 0.48	0.48 ± 0.48	0.48 ± 0.48
Spanish	0.66 ± 0.24	0.65 ± 0.24	0.42 ± 0.02	0.35 ± 0.42	0.35 ± 0.44	0.36 ± 0.44	0.36 ± 0.43
Tamil	0.57 ± 0.25	0.51 ± 0.27	0.43 ± 0.05	0.51 ± 0.44	0.53 ± 0.44	0.5 ± 0.44	0.5 ± 0.44
Urdu	0.75 ± 0.21	0.70 ± 0.24	0.43 ± 0.02	0.39 ± 0.48	0.39 ± 0.47	0.39 ± 0.48	0.39 ± 0.48
Wolof	0.51 ± 0.32	0.47 ± 0.32	0.41 ± 0.02	0.26 ± 0.39	0.25 ± 0.39	0.3 ± 0.43	0.27 ± 0.39
Yoruba	0.48 ± 0.07	0.36 ± 0.07	0.43 ± 0.06	0.33 ± 0.45	0.09 ± 0.05	0.16 ± 0.11	0.09 ± 0.05

Table 12: Probing performance (F_1 averaged by layers) of the BLOOM-based classifiers and count-based baselines. The results are averaged over probing tasks, and three experiment runs within each language. Standard deviation is determined by the results along the language tasks.

Figure 11 presents the language-wise probing performance results for morphosyntactic features represented at least in 5 languages. The probing performance of both LLMs is similar despite the difference in size. We find that the LLMs infer Mood and Person well with no regard for language. Number, NumType (numeral type), and Voice are moderately inferred in most languages. The models generally show worse qualities in the other categories, indicating that they do not encode such morphological information. The possible explanation of such difference in performance may be the diversity of possible values of these categories. For example, Mood and Person share similar values across the presented languages, while the set of Case values is highly dependent on the language.

Correlation The correlation analysis results support conclusions on the probing performance and reveals contributing factors (see Table 13). Both models show similar results on the languages with different language scripts. Results of BLOOM-1B7 are highly correlated with language family, probing dataset size, and pretraining dataset size. According to the results of Mann-Whitney U test, BLOOM-1B7 shows significantly better results ($p < 0.01$) than BLOOM. However, BLOOM shows more stable performance on different languages in spite of the amount of data it has seen during pretraining. This might indicate the better generalization abilities of the model with more parameters.

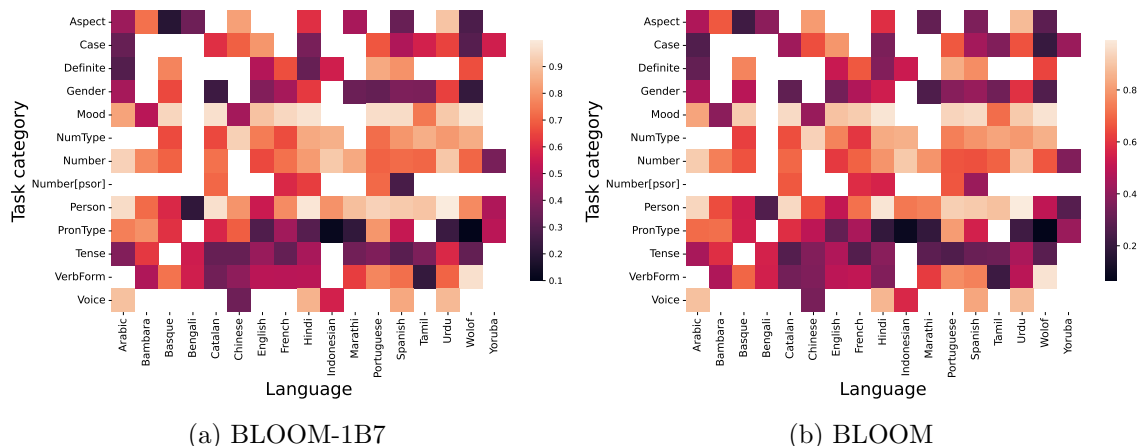

Figure 11: Probing classifiers’ results by language and task category. White squares denote that the morphosyntactic category is not represented in the language.

Criterion	Model	Test	p-value
Language script	BLOOM	Mann-Whitney U	0.72
	BLOOM-1B7		0.13
Language family	BLOOM	ANOVA	<0.01
	BLOOM-1B7		<0.01
Probing dataset size	BLOOM	Pearson	0.63
	BLOOM-1B7		0.02
Pretraining dataset size	BLOOM	Pearson	0.46
	BLOOM-1B7		<0.01
Difference between versions	BLOOM & BLOOM-1B7	Mann-Whitney U	<0.01

Table 13: Results of statistical tests and correlation analysis between probing performance and linguistic, dataset, and model configuration criteria.

4.9 Bias

As a preliminary study into the biases learned by BLOOM, we present evaluation on the multilingual CrowS-Pairs dataset, which combines a revised version of the CrowS-Pairs dataset developed by Nangia et al. (2020) together with the French version of CrowS-Pairs introduced by Névéol et al. (2022). One challenge of this evaluation was to adapt a dataset originally intended for masked language models to autoregressive language models such as BLOOM. CrowS-Pairs relies on minimal pairs to compare a stereotyped statement and a non-stereotyped statement (e.g. “*Women* can’t drive.” is a gender stereotype while “*Men* can’t drive” is not). The two statements differ only by the social category targeted by the stereotype and that social category is present in the stereotyped statement and not in the non-stereotyped statement. The evaluation aims at assessing systematic preference

of models for stereotyped statements. The original “metric score” compared pseudo-log-likelihood of sentences in a pair to determine which sentence received a higher score from a masked language model. Prompts were designed to require the model to select one of the statements based on the “likely” and “realistic” nature of the situations described.

Figure 12 shows that BLOOM’s overall prompt accuracy was close to .50, which suggests an overall absence of bias. We note that the scores in English and French are very close, suggesting similar overall behavior of the model on both languages. We also show results on mono-lingual autoregressive models — GPT-Neo (Black et al., 2021) and GPT-FR (Simoulin and Crabbé, 2021) for English and French, respectively.

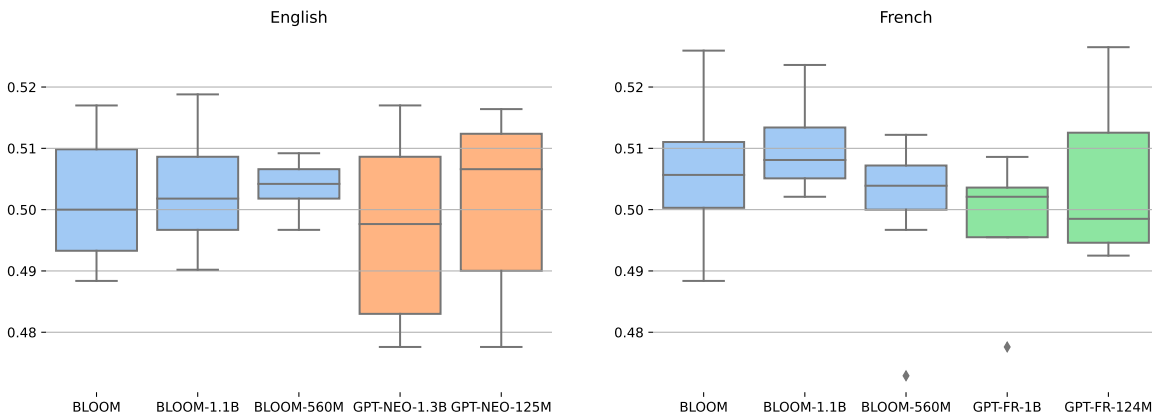

Figure 12: Overall accuracy of BLOOM on `crowS-Pairs` per prompt for English and French. Results on the two smallest BLOOM models and monolingual GPT models of comparable size are also shown.

Table 14 presents the results per bias type in the `CrowS-Pairs` dataset. The results are quite homogeneous over the categories, which contrasts with previous studies on masked language models, which suggested models were prone to bias in specific categories, which differed between models tested. Nonetheless, accuracy significantly differs from 50 (T-test, $p < .05$) overall for both languages, as well as for a number of bias categories, as shown per asterisks in the table.

Limitations Blodgett et al. (2021) discuss validity issues with the original `CrowS-Pairs` corpus. The `CrowS-Pairs` version used here differs from the original by addressing some of the issues pointed out by Blodgett et al. (2021) and by constructing 200 additional sentence pairs based on stereotypes collected from French speakers. In a recent evaluation of bias in masked language models in English and French, results obtained on the revised dataset were not significantly different from those obtained on the original dataset Névél et al. (2022). However, its original validation does not naturally apply here, and comparison to other `CrowS-Pairs` results is more difficult. For a stronger assessment of bias, results obtained with `CrowS-Pairs` should be compared with other measures of bias, and also assessed for all languages in the model. However, as noted by Talat et al. (2022), very little material (corpora, measures) is available for multilingual bias assessment.

Although our examinations suggest a limited presence of bias in the model, they cannot cover the breadth of possible usage scenarios. One such scenario where models may have a

Bias type	support	English	French
ethnicity color	460	50.05	50.48*
gender	321	51.17*	51.24*
socioeconomic status	196	51.05*	52.22*
nationality	253	49.25*	48.49*
religion	115	53.82*	53.01*
age	90	49.35	50.13
sexual orientation	91	50.00	49.9
physical appearance	72	48.20	49.67
disability	66	48.49*	49.16*
other	13	50.18	42.1*
All	1,677	49.78*	50.61*

Table 14: BLOOM accuracy results on `crowS-Pairs` bias categories averaged over eight runs for English and French. Significance for the one sample T-test ($p < .05$) is indicated with *.

larger impact is on linguistic diversity and language variation encountered. As the training resources for BLOOM are carefully curated, they may also capture some language variations to a larger degree than other models. This also impacts the ability of trained models to equitably represent different variations. Such differences can aid in the propagation and legitimization of some language variants over others. Our evaluation of biases in the model are further limited to the situations, languages and language variants that are covered by `multilingual CrowS-Pairs`. We therefore expect a distinction between our findings using `CrowS-Pairs` and wider model use (for a more detailed exploration on such differences, see Raji et al., 2021).

5. Conclusion

In this work, we present BLOOM, a 176B-parameter open-access multilingual language model. BLOOM was created by BigScience, a collaboration of hundreds of researchers, and was trained on the French government-funded Jean Zay supercomputer for 3.5 months. In this paper, we chronicled the development of BLOOM, from the creation of its training dataset `ROOTS` to the design of its architecture and tokenizer. We also discuss evaluation results of BLOOM and other large language models, finding it has competitive performance that improves after multitask finetuning.

We hope that the release of a powerful multilingual language model unlocks new applications and research directions for large language models. Further, we hope that documenting our experience will help the machine learning research community organize new large-scale collaborative projects similar to BigScience. Besides enabling results that are impossible for any individual research group to achieve, this form of organization will also allow more

people with different backgrounds to share their ideas and participate in the development of major advances in the field.

6. Contributions

Authors are assigned to each authorship category according to which aspects of the project they contributed to. Many authors appear under multiple categories because they contributed to the project in more than one way. Author order in all categories is alphabetical by first name, except for “Major Contributors” where authors are shuffled randomly apart from Teven Le Scao, who is intentionally listed first and “Organization” where Thomas Wolf is intentionally listed last. A description of each category follows. For finer-grained contribution details, please see the papers mentioned under each category.

Major Contributors lists individuals without whom BLOOM would not have happened and/or who spent more than 20% of their time on the BigScience effort as a whole.

Dataset lists individuals who contributed to data sourcing, organization, and processing efforts, including the authors of Laurençon et al. (2022), McMillan-Major et al. (2022), and Jernite et al. (2022).

Tokenization lists individuals who built the BLOOM tokenizer and authors of Mielke et al. (2021).

Prompt Engineering lists individuals who wrote, edited, and reviewed prompt templates for the datasets we consider as well as authors of Sanh et al. (2022), Bach et al. (2022), and Muennighoff et al. (2022b).

Architecture and Objective lists individuals who ran experiments to help determine BLOOM’s model architecture and training objective, including authors of Wang et al. (2022a) and Le Scao et al. (2022).

Engineering lists individuals who contributed to code and infrastructure to train BLOOM on the Jean Zay supercomputer.

Evaluation and interpretability lists individuals who helped evaluate the BLOOM model as well as authors of Talat et al. (2022).

Broader Impacts lists authors of the ethical charter, license, and model card, in addition to individuals who studied privacy issues, social impacts, and BLOOM’s carbon footprint.

Applications lists members of working groups focused on applications of BLOOM, including authors of Fries et al. (2022b), Fries et al. (2022a), and Toni et al. (2022).

Organiation lists individuals who coordinated the BigScience effort and authors of Akiki et al. (2022).

Acknowledgments

The BigScience Workshop was granted access to the HPC resources of the Institut du développement et des ressources en informatique scientifique (IDRIS) du Centre national de la recherche scientifique (CNRS) under the allocation 2021-A0101012475 made by the Grand équipement national de calcul intensif (GENCI). Model training ran on the Jean-Zay supercomputer of GENCI at IDRIS, and we thank the IDRIS team for their responsive support throughout the project, in particular Rémi Lacroix.

Roman Castagné, Thomas Wang, Benoît Sagot and Rachel Bawden’s contributions were funded by Benoît Sagot’s and Rachel Bawden’s chairs in the PRAIRIE institute funded by the French national agency ANR as part of the “Investissements d’avenir” programme under the reference ANR-19-P3IA-0001. Aurélie Névéol’s contribution was supported by ANR under grant GEM ANR-19-CE38-0012. Oskar van der Wal’s contributions were financed by the Dutch Research Council (NWO) as part of Open Competition Digitalisation-SSH with project number 406.DI.19.059.

The BigScience Workshop would also like to acknowledge the support and financing of the following organizations, organization members and affiliations of some of the participants: ESPCI and LAMSADE (Dauphine Université, PSL, CNRS) for Alexandre Al-lauzen; MELODI team at IRIT/University of Toulouse for Farah Benamara, Chloé Braud, Philippe Muller, and Véronique Moriceau; IRISA LinkMedia team IMATAG/CNRS for Vincent Claveau and Antoine Chaffin; Université de Lorraine ATILF UMR 7118 CNRS / UL for Mathieu Constant; University of Paris for Benoît Crabbé, Marie Candito and Antoine Simoulin; GdR TAL (CNRS) for Béatrice Daille; CNRS DR1 INSERM UMR1093 UBFC Dijon for Peter Ford Dominey; Aix-Marseille University UTLN CNRS LIS/UMR7220 for Benoît Favre and Frédéric Béchet; CEA LASTI for Bertrand Delezoide, Olivier Ferret, Adrian Popescu and Julien Tourille; Sorbonne Université LORIA for Karen Fort; CNRS DR1 LORIA UMR7503 Nancy for Claire Gardent and Christophe Cerisara; MAS Laboratory of Ecole Centrale Paris for Céline Hudelot, RCLN/LIPN UMR 7030 University Sorbonne-Paris-Nord/CNRS for Joseph Le Roux and Nadi Tomeh, Université de Paris and Necker - Enfants Malades hospital for Antoine Neuraz and Ivan Lerner, Université Paris Saclay LISN CNRS UMR9105 for Aurélie Névéol, Anne-Laure Ligozat, Caio Corro, Francois Yvon; Inria, Univ. Bordeaux and Ensta ParisTech for Pierre-Yves Oudeyer, Cédric Colas, Grgur Kovac, Tristan Karch; Inria Paris for Benoît Sagot, Djamé Seddah, Pedro Ortiz; University Toulouse CNRS for Ludovic Tanguy, Sorbonne Université, LIMICS (Sorbonne Université, Inserm, Univ. Sorbonne Paris Nord) for Xavier Tannier; I3S Laboratory, CNRS, INRIA, Université Cote d’Azur for Serena Villata and Elena Cabrio; Airbus, Central Research & Technology for Guillaume Alleon, Alexandre Arnold, and Catherine Kobus; Cloud Temple for Jean-Michel Dussoux; Illuin Technology for Robert Vesoul, Gautier Viaud, Martin d’Hoffschmidt, and Wacim Belblidia; Levia.ai for Romain Riviere; LightOn for Igor Carron, Laurent Daudet, Iacopo Poli, and Julien Launay; Nabla for Alexandre Lebrun, Martin Raison, and Samuel Humeau; Naver Labs Europe for Matthias Gallé and Laurent Besacier; Orange Labs for Géraldine Damnati, Johannes Heinecke, and Frederic Herledan; OVHcloud for Jean-Louis Queguiner and Guillaume Salou; ReciTAL for Thomas Scialom, Gilles Moyse, and Jacopo Staiano; Renault Group for Vincent Feuillard, Joan André, Francois-Paul Servant, Raphael Sourty, and Ayhan Uyanik; SYSTRAN for Jean Senellart, Josep Crego, Elise Michon, Guillaume Klein, Dakun Zhang, and Natalia Segal; Ubisoft for Guillaume Gaudron.

Hugging Face provided storage for the entirety of the project, as well as compute for development and part of training the smaller BLOOM models. Many of the evaluations in this paper were made possible by compute resources donated by CoreWeave and EleutherAI.

References

- Julien Abadji, Pedro Javier Ortiz Suárez, Laurent Romary, and Benoît Sagot. Ungoliant: An optimized pipeline for the generation of a very large-scale multilingual web corpus. In Harald Lüngen, Marc Kupietz, Piotr Bański, Adrien Barbaresi, Simon Clematide, and Ines Pisetta, editors, *Proceedings of the Workshop on Challenges in the Management of Large Corpora (CMLC-9)*, pages 1–9, Limerick, Ireland, 2021. Leibniz-Institut für Deutsche Sprache. doi: 10.14618/ids-pub-10468. URL <https://nbn-resolving.org/urn:nbn:de:bsz:mh39-104688>.
- Yossi Adi, Einat Kermany, Yonatan Belinkov, Ofer Lavi, and Yoav Goldberg. Fine-grained analysis of sentence embeddings using auxiliary prediction tasks. In *International Conference on Learning Representations (ICLR)*, April 2017.
- Christopher Akiki, Giada Pistilli, Margot Mieskes, Matthias Gallé, Thomas Wolf, Suzana Ilic, and Yacine Jernite. BigScience: A case study in the social construction of a multilingual large language model. In *Workshop on Broadening Research Collaborations 2022*, 2022. URL <https://openreview.net/forum?id=2e34612PP0m>.
- Rami Al-Rfou, Dokook Choe, Noah Constant, Mandy Guo, and Llion Jones. Character-level language modeling with deeper self-attention. In *Proceedings of the AAAI conference on artificial intelligence*, 2019.
- Yousef Altaher, Ali Fadel, Mazen Alotaibi, Mazen Alyazidi, Mishari Al-Mutairi, Mutlaq Aldhbuiub, Abdulrahman Mosaibah, Abdelrahman Rezk, Abdulrazzaq Alhendi, Mazen Abo Shal, Emad A. Alghamdi, Maged Saeed AlShaibani, Jezia Zakraoui, Wafaa Mohammed, Kamel Gaanoun, Khalid N. Elmadani, Mustafa Ghaleb, Nouamane Tazi, Raed Alharbi, Maraim Masoud, and Zaid Alyafeai. Masader plus: A new interface for exploring +500 arabic NLP datasets. *CoRR*, abs/2208.00932, 2022. doi: 10.48550/arXiv.2208.00932. URL <https://doi.org/10.48550/arXiv.2208.00932>.
- Zaid Alyafeai, Maraim Masoud, Mustafa Ghaleb, and Maged Saeed AlShaibani. Masader: Metadata sourcing for arabic text and speech data resources. *CoRR*, abs/2110.06744, 2021. URL <https://arxiv.org/abs/2110.06744>.
- Anonymous. Hungry hungry hippos: Towards language modeling with state space models. In *Submitted to The Eleventh International Conference on Learning Representations*, 2023. URL <https://openreview.net/forum?id=COZDyOWYGg>. under review.
- Stephen Bach, Victor Sanh, Zheng Xin Yong, Albert Webson, Colin Raffel, Nihal V. Nayak, Abheesht Sharma, Taewoon Kim, M Saiful Bari, Thibault Fevry, Zaid Alyafeai, Manan Dey, Andrea Santilli, Zhiqing Sun, Srulik Ben-david, Canwen Xu, Gunjan Chhablani, Han Wang, Jason Fries, Maged Al-shaibani, Shanya Sharma, Urmish Thakker, Khalid Almubarak, Xiangru Tang, Dragomir Radev, Mike Tian-jian Jiang, and Alexander Rush.

- PromptSource: An integrated development environment and repository for natural language prompts. In *Proceedings of the 60th Annual Meeting of the Association for Computational Linguistics: System Demonstrations*, pages 93–104, Dublin, Ireland, May 2022. Association for Computational Linguistics. doi: 10.18653/v1/2022.acl-demo.9. URL <https://aclanthology.org/2022.acl-demo.9>.
- Nesrine Bannour, Sahar Ghannay, Aurélie Névéal, and Anne-Laure Ligozat. Evaluating the carbon footprint of NLP methods: a survey and analysis of existing tools. In *Proceedings of the Second Workshop on Simple and Efficient Natural Language Processing*, pages 11–21, Virtual, November 2021. Association for Computational Linguistics. doi: 10.18653/v1/2021.sustainlp-1.2. URL <https://aclanthology.org/2021.sustainlp-1.2>.
- Rachel Bawden, Eric Bilinski, Thomas Lavergne, and Sophie Rosset. DiaBLa: A Corpus of Bilingual Spontaneous Written Dialogues for Machine Translation. *Language Resources and Evaluation*, pages 635–660, 2020. doi: 10.1007/s10579-020-09514-4. URL <https://doi.org/10.1007/s10579-020-09514-4>.
- Yonatan Belinkov. Probing classifiers: Promises, shortcomings, and advances. *Computational Linguistics*, 48(1):207–219, March 2022. doi: 10.1162/coli_a_00422. URL <https://aclanthology.org/2022.cl-1.7>.
- Yonatan Belinkov and James Glass. Analysis methods in neural language processing: A survey. *Transactions of the Association for Computational Linguistics*, 7:49–72, March 2019. doi: 10.1162/tacl_a_00254. URL <https://www.aclweb.org/anthology/Q19-1004>.
- Yonatan Belinkov, Nadir Durrani, Fahim Dalvi, Hassan Sajjad, and James Glass. What do neural machine translation models learn about morphology? In *Proceedings of the 55th Annual Meeting of the Association for Computational Linguistics (Volume 1: Long Papers)*, pages 861–872, Vancouver, Canada, July 2017. Association for Computational Linguistics. doi: 10.18653/v1/P17-1080. URL <https://www.aclweb.org/anthology/P17-1080>.
- Emily M Bender, Timnit Gebru, Angelina McMillan-Major, and Shmargaret Shmitchell. On the dangers of stochastic parrots: Can language models be too big? In *Proceedings of the 2021 ACM Conference on Fairness, Accountability, and Transparency*, pages 610–623, 2021.
- Yoshua Bengio, Réjean Ducharme, and Pascal Vincent. A neural probabilistic language model. *Advances in Neural Information Processing Systems*, 2000.
- Stella Biderman, Kieran Bicheno, and Leo Gao. Datasheet for the pile. *arXiv preprint arXiv:2201.07311*, 2022.
- BigScience Workshop. BLOOM (revision 4ab0472), 2022. URL <https://huggingface.co/bigscience/bloom>.
- Abeba Birhane, Vinay Uday Prabhu, and Emmanuel Kahembwe. Multimodal datasets: misogyny, pornography, and malignant stereotypes. *ArXiv*, abs/2110.01963, 2021.

- Abeba Birhane, Pratyusha Kalluri, Dallas Card, William Agnew, Ravit Dotan, and Michelle Bao. The values encoded in machine learning research. In *2022 ACM Conference on Fairness, Accountability, and Transparency, FAccT '22*, page 173–184, New York, NY, USA, 2022. Association for Computing Machinery. ISBN 9781450393522. doi: 10.1145/3531146.3533083. URL <https://doi.org/10.1145/3531146.3533083>.
- Sid Black, Leo Gao, Phil Wang, Connor Leahy, and Stella Biderman. GPT-Neo: Large scale autoregressive language modeling with mesh-tensorflow. *If you use this software, please cite it using these metadata*, 58, 2021.
- Sid Black, Stella Biderman, Eric Hallahan, Quentin Anthony, Leo Gao, Laurence Golding, Horace He, Connor Leahy, Kyle McDonell, Jason Phang, et al. GPT-NeoX-20B: An open-source autoregressive language model. *arXiv preprint arXiv:2204.06745*, 2022.
- Su Lin Blodgett, Gilsinia Lopez, Alexandra Olteanu, Robert Sim, and Hanna Wallach. Stereotyping Norwegian salmon: An inventory of pitfalls in fairness benchmark datasets. In *Proceedings of the 59th Annual Meeting of the Association for Computational Linguistics and the 11th International Joint Conference on Natural Language Processing (Volume 1: Long Papers)*, pages 1004–1015, Online, August 2021. Association for Computational Linguistics. doi: 10.18653/v1/2021.acl-long.81. URL <https://aclanthology.org/2021.acl-long.81>.
- Ondřej Bojar, Christian Buck, Christian Federmann, Barry Haddow, Philipp Koehn, Johannes Leveling, Christof Monz, Pavel Pecina, Matt Post, Herve Saint-Amand, Radu Soricut, Lucia Specia, and Aleš Tamchyna. Findings of the 2014 workshop on statistical machine translation. In *Proceedings of the Ninth Workshop on Statistical Machine Translation*, pages 12–58, Baltimore, Maryland, USA, June 2014. Association for Computational Linguistics. doi: 10.3115/v1/W14-3302. URL <https://aclanthology.org/W14-3302>.
- J. Scott Brennen. An industry-led debate: how uk media cover artificial intelligence, 2018.
- J Scott Brennen, Philip N Howard, and Rasmus K Nielsen. What to expect when you’re expecting robots: Futures, expectations, and pseudo-artificial general intelligence in uk news. *Journalism*, 23(1):22–38, 2022. doi: 10.1177/1464884920947535. URL <https://doi.org/10.1177/1464884920947535>.
- Tom Brown, Benjamin Mann, Nick Ryder, Melanie Subbiah, Jared D Kaplan, Prafulla Dhariwal, Arvind Neelakantan, Pranav Shyam, Girish Sastry, Amanda Askell, Sandhini Agarwal, Ariel Herbert-Voss, Gretchen Krueger, Tom Henighan, Rewon Child, Aditya Ramesh, Daniel Ziegler, Jeffrey Wu, Clemens Winter, Chris Hesse, Mark Chen, Eric Sigler, Mateusz Litwin, Scott Gray, Benjamin Chess, Jack Clark, Christopher Berner, Sam McCandlish, Alec Radford, Ilya Sutskever, and Dario Amodei. Language models are few-shot learners. *Advances in Neural Information Processing Systems*, 2020.
- Isaac Caswell, Julia Kreutzer, Lisa Wang, Ahsan Wahab, Daan van Esch, Nasanbayar Ulzii-Orshikh, Allahsera Auguste Tapo, Nishant Subramani, Artem Sokolov, Claytone Sikasote, Monang Setyawan, Supheakmungkol Sarin, Sokhar Samb, Benoît Sagot, Clara Rivera, Annette Rios Gonzales, Isabel Papadimitriou, Salomey Osei, Pedro Ortiz Suarez,

- Iroro Orife, Kelechi Ogueji, Rubungo Andre Niyongabo, Toan Q. Nguyen, Mathias Muller, Andre Matthias Muller, Shamsuddeen Hassan Muhammad, Nanda Firdausi Muhammad, Ayanda Mnyakeni, Jamshidbek Mirzakhlov, Tapiwanashe Matangira, Colin Leong, Nze Lawson, Sneha Kudugunta, Yacine Jernite, M. Jenny, Orhan Firat, Bonaventure F. P. Dossou, Sakhile Dlamini, Nisansa de Silva, Sakine cCabuk Balli, Stella Rose Biderman, Alessia Battisti, Ahmed Baruwa, Ankur Bapna, Pallavi N. Baljekar, Israel Abebe Azime, Ayodele Awokoya, Duygu Ataman, Orevaoghene Ahia, Oghenefego Ahia, Sweta Agrawal, and Mofetoluwa Adeyemi. Quality at a glance: An audit of web-crawled multilingual datasets. *Transactions of the Association for Computational Linguistics*, 10:50–72, 2022.
- Mark Chen, Jerry Tworek, Heewoo Jun, Qiming Yuan, Henrique Ponde de Oliveira Pinto, Jared Kaplan, Harri Edwards, Yuri Burda, Nicholas Joseph, Greg Brockman, et al. Evaluating large language models trained on code. *arXiv preprint arXiv:2107.03374*, 2021.
- Aakanksha Chowdhery, Sharan Narang, Jacob Devlin, Maarten Bosma, Gaurav Mishra, Adam Roberts, Paul Barham, Hyung Won Chung, Charles Sutton, Sebastian Gehrmann, et al. Palm: Scaling language modeling with pathways. *arXiv preprint arXiv:2204.02311*, 2022.
- Hyung Won Chung, Le Hou, Shayne Longpre, Barret Zoph, Yi Tay, William Fedus, Eric Li, Xuezhi Wang, Mostafa Dehghani, Siddhartha Brahma, et al. Scaling instruction-finetuned language models. *arXiv preprint arXiv:2210.11416*, 2022.
- Ronan Collobert, Jason Weston, Léon Bottou, Michael Karlen, Koray Kavukcuoglu, and Pavel Kuksa. Natural language processing (almost) from scratch. *Journal of machine learning research*, 12, 2011.
- Alexis Conneau, German Kruszewski, Guillaume Lample, Loïc Barrault, and Marco Baroni. What you can cram into a single $\&\#\&^*$ vector: Probing sentence embeddings for linguistic properties. In *Proceedings of the 56th Annual Meeting of the Association for Computational Linguistics (Volume 1: Long Papers)*, pages 2126–2136, Melbourne, Australia, July 2018. Association for Computational Linguistics. doi: 10.18653/v1/P18-1198. URL <https://aclanthology.org/P18-1198>.
- Alexis Conneau, Kartikay Khandelwal, Naman Goyal, Vishrav Chaudhary, Guillaume Wenzek, Francisco Guzmán, Edouard Grave, Myle Ott, Luke Zettlemoyer, and Veselin Stoyanov. Unsupervised cross-lingual representation learning at scale. In *Proceedings of the 58th Annual Meeting of the Association for Computational Linguistics*, pages 8440–8451, Online, July 2020. Association for Computational Linguistics. doi: 10.18653/v1/2020.acl-main.747. URL <https://aclanthology.org/2020.acl-main.747>.
- Danish Contractor, Daniel McDuff, Julia Katherine Haines, Jenny Lee, Christopher Hines, Brent Hecht, Nicholas Vincent, and Hanlin Li. Behavioral use licensing for responsible ai. In *2022 ACM Conference on Fairness, Accountability, and Transparency, FAccT '22*, page 778–788, New York, NY, USA, 2022. Association for Computing Machinery. ISBN 9781450393522. doi: 10.1145/3531146.3533143. URL <https://doi.org/10.1145/3531146.3533143>.

- Francesco De Toni, Christopher Akiki, Javier De La Rosa, Clémentine Fourier, Enrique Manjavacas, Stefan Schweter, and Daniel Van Strien. Entities, dates, and languages: Zero-shot on historical texts with t0. In *Proceedings of BigScience Episode #5 – Workshop on Challenges & Perspectives in Creating Large Language Models*, pages 75–83, virtual+Dublin, May 2022. Association for Computational Linguistics. doi: 10.18653/v1/2022.bigscience-1.7. URL <https://aclanthology.org/2022.bigscience-1.7>.
- Tim Dettmers, Mike Lewis, Younes Belkada, and Luke Zettlemoyer. LLM.int8(): 8-bit matrix multiplication for transformers at scale. *arXiv preprint arXiv:2208.07339*, 2022.
- Jacob Devlin, Ming-Wei Chang, Kenton Lee, and Kristina Toutanova. BERT: Pre-training of deep bidirectional transformers for language understanding. In *Conference of the North American Chapter of the Association for Computational Linguistics*, 2019.
- Jesse Dodge, Maarten Sap, Ana Marasović, William Agnew, Gabriel Ilharco, Dirk Groeneveld, Margaret Mitchell, and Matt Gardner. Documenting large webtext corpora: A case study on the colossal clean crawled corpus. In *Conference on Empirical Methods in Natural Language Processing*, 2021.
- Allyson Ettinger, Ahmed Elgohary, and Philip Resnik. Probing for semantic evidence of composition by means of simple classification tasks. In *Proceedings of the 1st Workshop on Evaluating Vector-Space Representations for NLP*, pages 134–139, Berlin, Germany, August 2016. Association for Computational Linguistics. doi: 10.18653/v1/W16-2524. URL <https://www.aclweb.org/anthology/W16-2524>.
- Angela Fan, Shruti Bhosale, Holger Schwenk, Zhiyi Ma, Ahmed El-Kishky, Siddharth Goyal, Mandeep Baines, Onur Celebi, Guillaume Wenzek, Vishrav Chaudhary, Naman Goyal, Tom Birch, Vitaliy Liptchinsky, Sergey Edunov, Michael Auli, and Armand Joulin. Beyond English-Centric multilingual machine translation. *Journal of Machine Learning Research*, 22(107):1–48, 2021. URL <http://jmlr.org/papers/v22/20-1307.html>.
- William Fedus, Barret Zoph, and Noam Shazeer. Switch transformers: Scaling to trillion parameter models with simple and efficient sparsity. *Journal of Machine Learning Research*, 23(120):1–39, 2022.
- Jack FitzGerald, Christopher Hench, Charith Peris, Scott Mackie, Kay Rottmann, Ana Sanchez, Aaron Nash, Liam Urbach, Vishesh Kakarala, Richa Singh, Swetha Ranganath, Laurie Crist, Misha Britan, Wouter Leeuwis, Gokhan Tur, and Prem Natarajan. Massive: A 1m-example multilingual natural language understanding dataset with 51 typologically-diverse languages, 2022. URL <https://arxiv.org/abs/2204.08582>.
- Daniel Fried, Armen Aghajanyan, Jessy Lin, Sida Wang, Eric Wallace, Freda Shi, Ruiqi Zhong, Wen-tau Yih, Luke Zettlemoyer, and Mike Lewis. InCoder: A generative model for code infilling and synthesis. *arXiv preprint arXiv:2204.05999*, 2022.
- Jason Alan Fries, Natasha Seelam, Gabriel Altay, Leon Weber, Myungsun Kang, Debajyoti Datta, Ruisi Su, Samuele Garda, Bo Wang, Simon Ott, Matthias Samwald, and Wojciech Kusa. Dataset debt in biomedical language modeling. In *Challenges & Perspectives*

in *Creating Large Language Models*, 2022a. URL <https://openreview.net/forum?id=HRfzInfr8Z9>.

Jason Alan Fries, Leon Weber, Natasha Seelam, Gabriel Altay, Debajyoti Datta, Samuele Garda, Myungsun Kang, Ruisi Su, Wojciech Kusa, Samuel Cahyawijaya, Fabio Barth, Simon Ott, Matthias Samwald, Stephen Bach, Stella Biderman, Mario Sanger, Bo Wang, Alison Callahan, Daniel Le3n Peri3an, Th3o Gigant, Patrick Haller, Jenny Chim, Jose David Posada, John Michael Giorgi, Karthik Rangasai Sivaraman, Marc Pamies, Marianna Nezhurina, Robert Martin, Michael Cullan, Moritz Freidank, Nathan Dahlberg, Shubhanshu Mishra, Shamik Bose, Nicholas Michio Broad, Yanis Labrak, Shlok S Deshmukh, Sid Kiblawi, Ayush Singh, Minh Chien Vu, Trishala Neeraj, Jonas Golde, Albert Villanova del Moral, and Benjamin Beilharz. BigBio: A framework for data-centric biomedical natural language processing. In *Thirty-sixth Conference on Neural Information Processing Systems Datasets and Benchmarks Track*, 2022b. URL <https://openreview.net/forum?id=81QDn9zTQ1W>.

Philip Gage. A new algorithm for data compression. *C Users J.*, 12(2):23–38, feb 1994. ISSN 0898-9788.

Leo Gao, Stella Biderman, Sid Black, Laurence Golding, Travis Hoppe, Charles Foster, Jason Phang, Horace He, Anish Thite, Noa Nabeshima, Shawn Presser, and Connor Leahy. The pile: An 800gb dataset of diverse text for language modeling. *arXiv preprint arXiv:2101.00027*, 2020.

Leo Gao, Jonathan Tow, Stella Biderman, Sid Black, Anthony DiPofi, Charles Foster, Laurence Golding, Jeffrey Hsu, Kyle McDonell, Niklas Muennighoff, Jason Phang, Laria Reynolds, Eric Tang, Anish Thite, Ben Wang, Kevin Wang, and Andy Zou. A framework for few-shot language model evaluation, September 2021. URL <https://doi.org/10.5281/zenodo.5371628>.

Sebastian Gehrmann, Abhik Bhattacharjee, Abinaya Mahendiran, Alex Wang, Alexandros Papangelis, Aman Madaan, Angelina McMillan-Major, Anna Shvets, Ashish Upadhyay, Bingsheng Yao, Bryan Wilie, Chandra Bhagavatula, Chaobin You, Craig Thomson, Cristina Garbacea, Dakuo Wang, Daniel Deutsch, Deyi Xiong, Di Jin, Dimitra Gkatzia, Dragomir Radev, Elizabeth Clark, Esin Durmus, Faisal Ladhak, Filip Ginter, Genta Indra Winata, Hendrik Strobelt, Hiroaki Hayashi, Jekaterina Novikova, Jenna Kanerva, Jenny Chim, Jiawei Zhou, Jordan Clive, Joshua Maynez, Jo3o Sedoc, Juraj Juraska, Kaustubh Dhole, Khyathi Raghavi Chandu, Laura Perez-Beltrachini, Leonardo F. R. Ribeiro, Lewis Tunstall, Li Zhang, Mahima Pushkarna, Mathias Creutz, Michael White, Mihir Sanjay Kale, Moussa Kamal Eddine, Nico Daheim, Nishant Subramani, Ondrej Dusek, Paul Pu Liang, Pawan Sasanka Ammanamanchi, Qi Zhu, Ratish Puduppully, Reno Kriz, Rifat Shahriyar, Ronald Cardenas, Saad Mahamood, Salomey Osei, Samuel Cahyawijaya, Sanja stajner, Sebastien Montella, Shailza, Shailza Jolly, Simon Mille, Tahmid Hasan, Tianhao Shen, Tosin Adewumi, Vikas Raunak, Vipul Raheja, Vitaly Nikolaev, Vivian Tsai, Yacine Jernite, Ying Xu, Yisi Sang, Yixin Liu, and Yufang Hou. Gemv2: Multilingual nlg benchmarking in a single line of code, 2022a. URL <https://arxiv.org/abs/2206.11249>.

- Sebastian Gehrmann, Elizabeth Clark, and Thibault Sellam. Repairing the cracked foundation: A survey of obstacles in evaluation practices for generated text, 2022b. URL <https://arxiv.org/abs/2202.06935>.
- Joshua T. Goodman. A bit of progress in language modeling. *Computer Speech & Language*, 15(4), 2001.
- Naman Goyal, Cynthia Gao, Vishrav Chaudhary, Peng-Jen Chen, Guillaume Wenzek, Da Ju, Sanjana Krishnan, Marc’Aurelio Ranzato, Francisco Guzmán, and Angela Fan. The Flores-101 evaluation benchmark for low-resource and multilingual machine translation. *Transactions of the Association for Computational Linguistics*, 10:522–538, 2022. doi: 10.1162/tacl_a_00474. URL <https://aclanthology.org/2022.tacl-1.30>.
- Alex Graves. Generating sequences with recurrent neural networks. *arXiv preprint arXiv:1308.0850*, 2013.
- Albert Gu, Tri Dao, Stefano Ermon, Atri Rudra, and Christopher Ré. Hippo: Recurrent memory with optimal polynomial projections. *Advances in Neural Information Processing Systems*, 33:1474–1487, 2020.
- Albert Gu, Karan Goel, and Christopher Re. Efficiently modeling long sequences with structured state spaces. In *International Conference on Learning Representations*, 2021.
- Joel Hestness, Sharan Narang, Newsha Ardalani, Gregory Diamos, Heewoo Jun, Hassan Kianinejad, Md Patwary, Mostofa Ali, Yang Yang, and Yanqi Zhou. Deep learning scaling is predictable, empirically. *arXiv preprint arXiv:1712.00409*, 2017.
- John Hewitt and Percy Liang. Designing and interpreting probes with control tasks. In *Proceedings of the 2019 Conference on Empirical Methods in Natural Language Processing and the 9th International Joint Conference on Natural Language Processing (EMNLP-IJCNLP)*, pages 2733–2743, Hong Kong, China, November 2019. Association for Computational Linguistics. doi: 10.18653/v1/D19-1275. URL <https://aclanthology.org/D19-1275>.
- Jordan Hoffmann, Sebastian Borgeaud, Arthur Mensch, Elena Buchatskaya, Trevor Cai, Eliza Rutherford, Diego de Las Casas, Lisa Anne Hendricks, Johannes Welbl, Aidan Clark, Tom Hennigan, Eric Noland, Katie Millican, George van den Driessche, Bogdan Damoc, Aurelia Guy, Simon Osindero, Karen Simonyan, Erich Elsen, Jack W. Rae, Oriol Vinyals, and Laurent Sifre. Training compute-optimal large language models. *arXiv preprint arXiv:2203.15556*, 2022.
- Jeremy Howard and Sebastian Ruder. Universal language model fine-tuning for text classification. In *Annual Meeting of the Association for Computational Linguistics*, 2018.
- Dieuwke Hupkes, Sara Veldhoen, and Willem Zuidema. Visualisation and ‘diagnostic classifiers’ reveal how recurrent and recursive neural networks process hierarchical structure. *Journal of Artificial Intelligence Research*, 61:907–926, 2018.

- Yacine Jernite, Huu Nguyen, Stella Biderman, Anna Rogers, Maraim Masoud, Valentin Danchev, Samson Tan, Alexandra Sasha Luccioni, Nishant Subramani, Isaac Johnson, Gerard Dupont, Jesse Dodge, Kyle Lo, Zeerak Talat, Dragomir Radev, Aaron Gokaslan, Somaieh Nikpoor, Peter Henderson, Rishi Bommasani, and Margaret Mitchell. Data governance in the age of large-scale data-driven language technology. In *2022 ACM Conference on Fairness, Accountability, and Transparency, FAccT '22*, page 2206–2222, New York, NY, USA, 2022. Association for Computing Machinery. ISBN 9781450393522. doi: 10.1145/3531146.3534637. URL <https://doi.org/10.1145/3531146.3534637>.
- Rebecca Lynn Johnson, Giada Pistilli, Natalia Men’endez-Gonz’alez, Leslye Denisse Dias Duran, Enrico Panai, Julija Kalpokienė, and Donald Jay Bertulfo. The ghost in the machine has an american accent: value conflict in gpt-3. *ArXiv*, abs/2203.07785, 2022.
- Dhiraj Kalamkar, Dheevatsa Mudigere, Naveen Mellempudi, Dipankar Das, Kunal Banerjee, Sasikanth Avancha, Dharma Teja Vooturi, Nataraj Jammalamadaka, Jianyu Huang, Hector Yuen, Jiyan Yang, Jongsoo Park, Alexander Heinecke, Evangelos Georganas, Sudarshan Srinivasan, Abhisek Kundu, Misha Smelyanskiy, Bharat Kaul, and Pradeep Dubey. A study of bfloat16 for deep learning training, 2019.
- Jared Kaplan, Sam McCandlish, Tom Henighan, Tom B Brown, Benjamin Chess, Rewon Child, Scott Gray, Alec Radford, Jeffrey Wu, and Dario Amodei. Scaling laws for neural language models. *arXiv preprint arXiv:2001.08361*, 2020.
- Boseop Kim, HyoungSeok Kim, Sang-Woo Lee, Gichang Lee, Donghyun Kwak, Jeon Dong Hyeon, Sunghyun Park, Sungju Kim, Seonhoon Kim, Dongpil Seo, Heungsub Lee, Minyoung Jeong, Sungjae Lee, Minsub Kim, Suk Hyun Ko, Seokhun Kim, Taeyong Park, Jinuk Kim, Soyong Kang, Na-Hyeon Ryu, Kang Min Yoo, Minsuk Chang, Soobin Suh, Sookyo In, Jinseong Park, Kyungduk Kim, Hiun Kim, Jisu Jeong, Yong Goo Yeo, Donghoon Ham, Dongju Park, Min Young Lee, Jaewook Kang, Inho Kang, Jung-Woo Ha, Woomyoung Park, and Nako Sung. What changes can large-scale language models bring? intensive study on HyperCLOVA: Billions-scale korean generative pretrained transformers. In *Conference on Empirical Methods in Natural Language Processing*, 2021.
- Walter Klöpffer. Life cycle assessment. *Environmental Science and Pollution Research*, 4 (4):223–228, 1997.
- Taku Kudo and John Richardson. SentencePiece: A simple and language independent sub-word tokenizer and detokenizer for neural text processing. In *Proceedings of the 2018 Conference on Empirical Methods in Natural Language Processing: System Demonstrations*, pages 66–71, Brussels, Belgium, November 2018. Association for Computational Linguistics. doi: 10.18653/v1/D18-2012. URL <https://aclanthology.org/D18-2012>.
- Anoop Kunchukuttan, Divyanshu Kakwani, Satish Golla, C. GokulN., Avik Bhattacharyya, Mitesh M. Khapra, and Pratyush Kumar. Ai4bharat-indicnlp corpus: Monolingual corpora and word embeddings for indic languages. *ArXiv*, abs/2005.00085, 2020.
- Alexandre Lacoste, Alexandra Luccioni, Victor Schmidt, and Thomas Dandres. Quantifying the carbon emissions of machine learning. *arXiv preprint arXiv:1910.09700*, 2019.

- Faisal Ladhak, Esin Durmus, Claire Cardie, and Kathleen McKeown. WikiLingua: A new benchmark dataset for cross-lingual abstractive summarization. In *Findings of the Association for Computational Linguistics: EMNLP 2020*, pages 4034–4048, Online, November 2020. Association for Computational Linguistics. doi: 10.18653/v1/2020.findings-emnlp.360. URL <https://aclanthology.org/2020.findings-emnlp.360>.
- Hugo Laurençon, Lucile Saulnier, Thomas Wang, Christopher Akiki, Albert Villanova del Moral, Teven Le Scao, Leandro Von Werra, Chenghao Mou, Eduardo González Ponferada, Huu Nguyen, Jörg Frohberg, Mario Šaško, Quentin Lhoest, Angelina McMillan-Major, Gérard Dupont, Stella Biderman, Anna Rogers, Loubna Ben allal, Francesco De Toni, Giada Pistilli, Olivier Nguyen, Somaieh Nikpoor, Maraim Masoud, Pierre Colombo, Javier de la Rosa, Paulo Villegas, Tristan Thrush, Shayne Longpre, Sebastian Nagel, Leon Weber, Manuel Romero Muñoz, Jian Zhu, Daniel Van Strien, Zaid Alyafeai, Khalid Almubarak, Vu Minh Chien, Itziar Gonzalez-Dios, Aitor Soroa, Kyle Lo, Manan Dey, Pedro Ortiz Suarez, Aaron Gokaslan, Shamik Bose, David Ifeoluwa Adelani, Long Phan, Hieu Tran, Ian Yu, Suhas Pai, Jenny Chim, Violette Lepercq, Suzana Ilic, Margaret Mitchell, Sasha Luccioni, and Yacine Jernite. The BigScience ROOTS corpus: A 1.6TB composite multilingual dataset. In *Thirty-sixth Conference on Neural Information Processing Systems Datasets and Benchmarks Track*, 2022. URL <https://openreview.net/forum?id=UoEw6KigkUn>.
- Teven Le Scao, Thomas Wang, Daniel Hesslow, Lucile Saulnier, Stas Bekman, M Saiful Bari, Stella Biderman, Hady Elsahar, Niklas Muennighoff, Jason Phang, Ofir Press, Colin Raffel, Victor Sanh, Sheng Shen, Lintang Sutawika, Jaesung Tae, Zheng Xin Yong, Julien Launay, and Iz Beltagy. What language model to train if you have one million GPU hours? In *Challenges & Perspectives in Creating Large Language Models*, 2022. URL <https://openreview.net/forum?id=rI7BL3fHIZq>.
- Mike Lewis, Yinhan Liu, Naman Goyal, Marjan Ghazvininejad, Abdelrahman Mohamed, Omer Levy, Veselin Stoyanov, and Luke Zettlemoyer. BART: Denoising sequence-to-sequence pre-training for natural language generation, translation, and comprehension. In *Annual Meeting of the Association for Computational Linguistics*, 2020.
- Quentin Lhoest, Albert Villanova del Moral, Yacine Jernite, Abhishek Thakur, Patrick von Platen, Suraj Patil, Julien Chaumond, Mariama Drame, Julien Plu, Lewis Tunstall, Joe Davison, Mario Šaško, Gunjan Chhablani, Bhavitvya Malik, Simon Brandeis, Teven Le Scao, Victor Sanh, Canwen Xu, Nicolas Patry, Angelina McMillan-Major, Philipp Schmid, Sylvain Gugger, Clément Delangue, Théo Matussière, Lysandre Debut, Stas Bekman, Pierric Cistac, Thibault Goehringer, Victor Mustar, François Lagunas, Alexander Rush, and Thomas Wolf. Datasets: A community library for natural language processing. In *Proceedings of the 2021 Conference on Empirical Methods in Natural Language Processing: System Demonstrations*, pages 175–184, Online and Punta Cana, Dominican Republic, November 2021. Association for Computational Linguistics. doi: 10.18653/v1/2021.emnlp-demo.21. URL <https://aclanthology.org/2021.emnlp-demo.21>.
- Yujia Li, David H. Choi, Junyoung Chung, Nate Kushman, Julian Schrittwieser, Rémi Leblond, Tom Eccles, James Keeling, Felix Gimeno, Agustin Dal Lago, Thomas Hu-

- bert, Peter Choy, Cyprien de Masson d’Autume, Igor Babuschkin, Xinyun Chen, Po-Sen Huang, Johannes Welbl, Sven Gowal, Alexey Cherepanov, James Molloy, Daniel J. Mankowitz, Esme Sutherland Robson, Pushmeet Kohli, Nando de Freitas, Koray Kavukcuoglu, and Oriol Vinyals. Competition-level code generation with AlphaCode. *CoRR*, abs/2203.07814, 2022. doi: 10.48550/arXiv.2203.07814. URL <https://doi.org/10.48550/arXiv.2203.07814>.
- Chin-Yew Lin. ROUGE: A package for automatic evaluation of summaries. In *Text Summarization Branches Out*, pages 74–81, Barcelona, Spain, July 2004. Association for Computational Linguistics. URL <https://aclanthology.org/W04-1013>.
- Xi Victoria Lin, Todor Mihaylov, Mikel Artetxe, Tianlu Wang, Shuohui Chen, Daniel Simig, Myle Ott, Naman Goyal, Shruti Bhosale, Jingfei Du, Ramakanth Pasunuru, Sam Shleifer, Punit Singh Koura, Vishrav Chaudhary, Brian O’Horo, Jeff Wang, Luke Zettlemoyer, Zornitsa Kozareva, Mona Diab, Veselin Stoyanov, and Xian Li. Few-shot learning with multilingual language models, 2021. URL <https://arxiv.org/abs/2112.10668>.
- Yinhan Liu, Myle Ott, Naman Goyal, Jingfei Du, Mandar Joshi, Danqi Chen, Omer Levy, Mike Lewis, Luke Zettlemoyer, and Veselin Stoyanov. RoBERTa: A robustly optimized BERT pretraining approach. *arXiv preprint arXiv:1907.11692*, 2019.
- Kyle Lo, Lucy Lu Wang, Mark Neumann, Rodney Michael Kinney, and Daniel S. Weld. S2ORC: The semantic scholar open research corpus. In *ACL*, 2020.
- Ilya Loshchilov and Frank Hutter. SGDR: stochastic gradient descent with restarts. *CoRR*, abs/1608.03983, 2016. URL <http://arxiv.org/abs/1608.03983>.
- Alexandra Sasha Luccioni, Sylvain Viguiet, and Anne-Laure Ligozat. Estimating the Carbon Footprint of BLOOM, a 176B Parameter Language Model. *arXiv preprint arXiv:2211.02001*, 2022.
- Harish Tayyar Madabushi, Edward Gow-Smith, Marcos Garcia, Carolina Scarton, Marco Idiart, and Aline Villavicencio. Semeval-2022 task 2: Multilingual idiomaticity detection and sentence embedding. *arXiv preprint arXiv:2204.10050*, 2022.
- H Mann and D Whitney. Controlling the false discovery rate: A practical and powerful approach to multiple testing. *Ann. Math. Stat.*, 18(1):50–60, 1947.
- Louis Martin, Benjamin Muller, Pedro Javier Ortiz Suárez, Yoann Dupont, Laurent Romary, Éric de la Clergerie, Djamé Seddah, and Benoît Sagot. CamemBERT: a tasty French language model. In *Proceedings of the 58th Annual Meeting of the Association for Computational Linguistics*, pages 7203–7219, Online, July 2020. Association for Computational Linguistics. URL <https://www.aclweb.org/anthology/2020.acl-main.645>.
- Angelina McMillan-Major, Zaid Alyafeai, Stella Biderman, Kimbo Chen, Francesco De Toni, Gérard Dupont, Hady Elsahar, Chris Emezue, Alham Fikri Aji, Suzana Ilić, Nurulaqilla Khamis, Colin Leong, Maraim Masoud, Aitor Soroa, Pedro Ortiz Suarez, Zeerak Talat, Daniel van Strien, and Yacine Jernite. Documenting geographically and contextually

- diverse data sources: The bigscience catalogue of language data and resources, 2022. URL <https://arxiv.org/abs/2201.10066>.
- Paulius Micikevicius, Sharan Narang, Jonah Alben, Gregory Diamos, Erich Elsen, David Garcia, Boris Ginsburg, Michael Houston, Oleksii Kuchaiev, Ganesh Venkatesh, and Hao Wu. Mixed precision training. In *International Conference on Learning Representations*, 2018. URL <https://openreview.net/forum?id=r1gs9JgRZ>.
- Sabrina J. Mielke, Zaid Alyafeai, Elizabeth Salesky, Colin Raffel, Manan Dey, Matthias Gallé, Arun Raja, Chenglei Si, Wilson Y. Lee, Benoît Sagot, and Samson Tan. Between words and characters: A brief history of open-vocabulary modeling and tokenization in nlp, 2021. URL <https://arxiv.org/abs/2112.10508>.
- Risto Miikkulainen and Michael G. Dyer. Natural language processing with modular pdp networks and distributed lexicon. *Cognitive Science*, 15(3), 1991.
- Tomas Mikolov, Martin Karafiát, Lukas Burget, Jan Cernocký, and Sanjeev Khudanpur. Recurrent neural network based language model. In *Interspeech*, 2010.
- Tomas Mikolov, Ilya Sutskever, Kai Chen, Greg S. Corrado, and Jeff Dean. Distributed representations of words and phrases and their compositionality. *Advances in neural information processing systems*, 26, 2013.
- Margaret Mitchell, Simone Wu, Andrew Zaldivar, Parker Barnes, Lucy Vasserman, Ben Hutchinson, Elena Spitzer, Inioluwa Deborah Raji, and Timnit Gebru. Model cards for model reporting. In *Proceedings of the Conference on Fairness, Accountability, and Transparency, FAT* '19*, page 220–229, New York, NY, USA, 2019. Association for Computing Machinery. ISBN 9781450361255. doi: 10.1145/3287560.3287596. URL <https://doi.org/10.1145/3287560.3287596>.
- Anthony Moi, Pierric Cistac, Nicolas Patry, Evan P. Walsh, Funtowicz Morgan, Sebastian Pütz, Thomas Wolf, Sylvain Gugger, Clément Delangue, Julien Chaumond, Lysandre Debut, and Patrick von Platen. Hugging face tokenizers library. <https://github.com/huggingface/tokenizers>, 2019.
- Niklas Muennighoff. SGPT: GPT sentence embeddings for semantic search. *arXiv preprint arXiv:2202.08904*, 2022.
- Niklas Muennighoff, Nouamane Tazi, Loïc Magne, and Nils Reimers. MTEB: Massive text embedding benchmark. *arXiv preprint arXiv:2210.07316*, 2022a.
- Niklas Muennighoff, Thomas Wang, Lintang Sutawika, Adam Roberts, Stella Biderman, Teven Le Scao, M Saiful Bari, Sheng Shen, Zheng-Xin Yong, Hailey Schoelkopf, Xian-gru Tang, Dragomir Radev, Alham Fikri Aji, Khalid Almubarak, Samuel Albanie, Zaid Alyafeai, Albert Webson, Edward Raff, and Colin Raffel. Crosslingual generalization through multitask finetuning, 2022b.
- Nikita Nangia, Clara Vania, Rasika Bhalerao, and Samuel R. Bowman. CrowS-pairs: A challenge dataset for measuring social biases in masked language models. In *Proceedings of the 2020 Conference on Empirical Methods in Natural Language Processing*

- (*EMNLP*), pages 1953–1967, Online, November 2020. Association for Computational Linguistics. doi: 10.18653/v1/2020.emnlp-main.154. URL <https://aclanthology.org/2020.emnlp-main.154>.
- Sharan Narang, Hyung Won Chung, Yi Tay, William Fedus, Thibault Fevry, Michael Matena, Karishma Malkan, Noah Fiedel, Noam Shazeer, Zhenzhong Lan, Yanqi Zhou, Wei Li, Nan Ding, Jake Marcus, Adam Roberts, and Colin Raffel. Do transformer modifications transfer across implementations and applications? In *Conference on Empirical Methods in Natural Language Processing*, 2021.
- Wilhelmina Nekoto, Vukosi Marivate, Tshinondiwa Matsila, Timi E. Fasubaa, T Kolawole, Taiwo Helen Fagbohunbe, Solomon Oluwole Akinola, Shamsuddeen Hassan Muhammad, Salomon Kabongo KABENAMUALU, Salomey Osei, Sackey Freshia, Rubungo Andre Niyongabo, Ricky Macharm, Perez Ogayo, Orevaoghene Ahia, Musie Meressa, Mofetoluwa Adeyemi, Masabata Mokgesi-Selinga, Lawrence Okegbemi, Laura Martinus, Kolawole Tajudeen, Kevin Degila, Kelechi Ogueji, Kathleen Siminyu, Julia Kreutzer, Jason Webster, Jamiil Toure Ali, Jade Z. Abbott, Iroro Orife, Ignatius U. Ezeani, Idris Abdulkabir Dangana, Herman Kamper, Hady ElSahar, Goodness Duru, Ghollah Kioko, Espoir Murhabazi, Elan Van Biljon, Daniel Whitenack, Christopher Onyefuluchi, Chris C. Emezue, Bonaventure F. P. Dossou, Blessing K. Sibanda, Blessing Itoro Bassey, Ayodele Olabiyi, Arshath Ramkilowan, Alp Oktem, Adewale Akinfaderin, and Abdallah M. Bashir. Participatory research for low-resourced machine translation: A case study in african languages. In *FINDINGS*, 2020.
- Aurélie Névéol, Yoann Dupont, Julien Bezançon, and Karèn Fort. French CrowS-pairs: Extending a challenge dataset for measuring social bias in masked language models to a language other than English. In *Proceedings of the 60th Annual Meeting of the Association for Computational Linguistics (Volume 1: Long Papers)*, pages 8521–8531, Dublin, Ireland, May 2022. Association for Computational Linguistics. doi: 10.18653/v1/2022.acl-long.583. URL <https://aclanthology.org/2022.acl-long.583>.
- Joakim Nivre, Marie-Catherine de Marneffe, Filip Ginter, Yoav Goldberg, Jan Hajič, Christopher D. Manning, Ryan McDonald, Slav Petrov, Sampo Pyysalo, Natalia Silveira, Reut Tsarfaty, and Daniel Zeman. Universal Dependencies v1: A multilingual treebank collection. In *Proceedings of the Tenth International Conference on Language Resources and Evaluation (LREC’16)*, pages 1659–1666, Portorož, Slovenia, May 2016. European Language Resources Association (ELRA). URL <https://aclanthology.org/L16-1262>.
- Joakim Nivre, Daniel Zeman, Filip Ginter, and Francis Tyers. Universal Dependencies. In *Proceedings of the 15th Conference of the European Chapter of the Association for Computational Linguistics: Tutorial Abstracts*, Valencia, Spain, April 2017. Association for Computational Linguistics. URL <https://aclanthology.org/E17-5001>.
- Pedro Javier Ortiz Suárez, Benoît Sagot, and Laurent Romary. Asynchronous pipelines for processing huge corpora on medium to low resource infrastructures. In Piotr Bański, Adrien Barbaresi, Hanno Biber, Evelyn Breiteneder, Simon Clematide, Marc Kupietz, Harald Lungen, and Caroline Iliadi, editors, *Proceedings of the Workshop on*

- Challenges in the Management of Large Corpora (CMLC-7)*, pages 9 – 16, Cardiff, UK, 2019. Leibniz-Institut für Deutsche Sprache. doi: 10.14618/ids-pub-9021. URL <http://nbn-resolving.de/urn:nbn:de:bsz:mh39-90215>.
- Kishore Papineni, Salim Roukos, Todd Ward, and Wei-Jing Zhu. BLEU: a method for automatic evaluation of machine translation. In *Proceedings of the 40th Annual Meeting of the Association for Computational Linguistics*, pages 311–318, Philadelphia, Pennsylvania, USA, July 2002. Association for Computational Linguistics. doi: 10.3115/1073083.1073135. URL <https://aclanthology.org/P02-1040>.
- David Patterson, Joseph Gonzalez, Quoc Le, Chen Liang, Lluís-Miquel Munguia, Daniel Rothchild, David So, Maud Texier, and Jeff Dean. Carbon emissions and large neural network training. *arXiv preprint arXiv:2104.10350*, 2021.
- Karl Pearson. Vii. note on regression and inheritance in the case of two parents. *proceedings of the royal society of London*, 58(347-352):240–242, 1895.
- Matthew E. Peters, Mark Neumann, Mohit Iyyer, Matt Gardner, Christopher Clark, Kenton Lee, and Luke Zettlemoyer. Deep contextualized word representations. In *Conference of the North American Chapter of the Association for Computational Linguistics*, 2018.
- Jason Phang, Herbie Bradley, Leo Gao, Louis J Castricato, and Stella Biderman. EleutherAI: going beyond "open science" to "science in the open". In *Workshop on Broadening Research Collaborations*, 2022.
- Matt Post. A call for clarity in reporting BLEU scores. In *Proceedings of the Third Conference on Machine Translation: Research Papers*, pages 186–191, Brussels, Belgium, October 2018. Association for Computational Linguistics. doi: 10.18653/v1/W18-6319. URL <https://aclanthology.org/W18-6319>.
- Ofir Press, Noah Smith, and Mike Lewis. Train short, test long: Attention with linear biases enables input length extrapolation. In *International Conference on Learning Representations*, 2021.
- Alec Radford, Karthik Narasimhan, Tim Salimans, and Ilya Sutskever. Improving language understanding by generative pre-training, 2018.
- Alec Radford, Jeffrey Wu, Rewon Child, David Luan, Dario Amodei, and Ilya Sutskever. Language models are unsupervised multitask learners, 2019.
- Jack W Rae, Sebastian Borgeaud, Trevor Cai, Katie Millican, Jordan Hoffmann, Francis Song, John Aslanides, Sarah Henderson, Roman Ring, Susannah Young, et al. Scaling language models: Methods, analysis & insights from training gopher. *arXiv preprint arXiv:2112.11446*, 2021.
- Colin Raffel, Noam Shazeer, Adam Roberts, Katherine Lee, Sharan Narang, Michael Matena, Yanqi Zhou, Wei Li, Peter J Liu, et al. Exploring the limits of transfer learning with a unified text-to-text transformer. *J. Mach. Learn. Res.*, 21(140):1–67, 2020.

- Samyam Rajbhandari, Jeff Rasley, Olatunji Ruwase, and Yuxiong He. ZeRO: Memory optimizations toward training trillion parameter models. *SC20: International Conference for High Performance Computing, Networking, Storage and Analysis*, Nov 2020. doi: 10.1109/sc41405.2020.00024. URL <http://dx.doi.org/10.1109/SC41405.2020.00024>.
- Deborah Raji, Emily Denton, Emily M. Bender, Alex Hanna, and Amanda-lynn Paullada. Ai and the everything in the whole wide world benchmark. In J. Vanschoren and S. Yeung, editors, *Proceedings of the Neural Information Processing Systems Track on Datasets and Benchmarks*, volume 1, 2021. URL <https://datasets-benchmarks-proceedings.neurips.cc/paper/2021/file/084b6fbb10729ed4da8c3d3f5a3ae7c9-Paper-round2.pdf>.
- Inioluwa Deborah Raji, I. Elizabeth Kumar, Aaron Horowitz, and Andrew Selbst. The fallacy of ai functionality. In *2022 ACM Conference on Fairness, Accountability, and Transparency, FAccT '22*, page 959–972, New York, NY, USA, 2022. Association for Computing Machinery. ISBN 9781450393522. doi: 10.1145/3531146.3533158. URL <https://doi.org/10.1145/3531146.3533158>.
- Jeff Rasley, Samyam Rajbhandari, Olatunji Ruwase, and Yuxiong He. DeepSpeed: System optimizations enable training deep learning models with over 100 billion parameters. In *Proceedings of the 26th ACM SIGKDD International Conference on Knowledge Discovery & Data Mining, KDD '20*, page 3505–3506, New York, NY, USA, 2020. Association for Computing Machinery. ISBN 9781450379984. doi: 10.1145/3394486.3406703. URL <https://doi.org/10.1145/3394486.3406703>.
- Phillip Rust, Jonas Pfeiffer, Ivan Vulić, Sebastian Ruder, and Iryna Gurevych. How good is your tokenizer? on the monolingual performance of multilingual language models. In *Proceedings of the 59th Annual Meeting of the Association for Computational Linguistics and the 11th International Joint Conference on Natural Language Processing (Volume 1: Long Papers)*, pages 3118–3135, Online, August 2021. Association for Computational Linguistics. doi: 10.18653/v1/2021.acl-long.243. URL <https://aclanthology.org/2021.acl-long.243>.
- Ali Safaya, Moutasem Abdullatif, and Deniz Yuret. KUISAIL at SemEval-2020 task 12: BERT-CNN for offensive speech identification in social media. In *Proceedings of the Fourteenth Workshop on Semantic Evaluation*, pages 2054–2059, Barcelona (online), December 2020. International Committee for Computational Linguistics. URL <https://www.aclweb.org/anthology/2020.semeval-1.271>.
- Gerard Salton and Chung-Shu Yang. On the specification of term values in automatic indexing. *Journal of documentation*, 1973.
- Nithya Sambasivan, Shivani Kapania, Hannah Highfill, Diana Akrong, Praveen Paritosh, and Lora M Aroyo. “everyone wants to do the model work, not the data work”: Data cascades in high-stakes ai. In *Proceedings of the 2021 CHI Conference on Human Factors in Computing Systems, CHI '21*, New York, NY, USA, 2021. Association for Computing Machinery. ISBN 9781450380966. doi: 10.1145/3411764.3445518. URL <https://doi.org/10.1145/3411764.3445518>.

- Victor Sanh, Albert Webson, Colin Raffel, Stephen Bach, Lintang Sutawika, Zaid Alyafeai, Antoine Chaffin, Arnaud Stiegler, Arun Raja, Manan Dey, M Saiful Bari, Canwen Xu, Urmish Thakker, Shanya Sharma Sharma, Eliza Szczechla, Taewoon Kim, Gunjan Chhablani, Nihal Nayak, Debajyoti Datta, Jonathan Chang, Mike Tian-Jian Jiang, Han Wang, Matteo Manica, Sheng Shen, Zheng Xin Yong, Harshit Pandey, Rachel Bawden, Thomas Wang, Trishala Neeraj, Jos Rozen, Abheesht Sharma, Andrea Santilli, Thibault Fevry, Jason Alan Fries, Ryan Teehan, Teven Le Scao, Stella Biderman, Leo Gao, Thomas Wolf, and Alexander M Rush. Multitask prompted training enables zero-shot task generalization. In *International Conference on Learning Representations*, 2022. URL <https://openreview.net/forum?id=9Vrb9DOWI4>.
- Jürgen Schmidhuber and Stefan Heil. Sequential neural text compression. *IEEE Transactions on Neural Networks*, 7(1), 1996.
- Roy Schwartz, Jesse Dodge, Noah A. Smith, and Oren Etzioni. Green ai. *Communications of the ACM*, 63(12), 2020.
- Oleg Serikov, Vitaly Protasov, Ekaterina Voloshina, Viktoria Knyazkova, and Tatiana Shavrina. Universal and independent: Multilingual probing framework for exhaustive model interpretation and evaluation. *arXiv preprint arXiv:2210.13236*, 2022.
- Claude Elwood Shannon. A mathematical theory of communication. *The Bell system technical journal*, 27(3), 1948.
- Noam Shazeer. GLU variants improve transformer. *arXiv preprint arXiv:2002.05202*, 2020.
- Noam Shazeer, Azalia Mirhoseini, Krzysztof Maziarz, Andy Davis, Quoc Le, Geoffrey Hinton, and Jeff Dean. Outrageously large neural networks: The sparsely-gated mixture-of-experts layer. In *International Conference on Learning Representations*, 2017. URL <https://openreview.net/forum?id=B1ckMDq1g>.
- Oleh Shliazhko, Alena Fenogenova, Maria Tikhonova, Vladislav Mikhailov, Anastasia Kozlova, and Tatiana Shavrina. mgpt: Few-shot learners go multilingual. *arXiv preprint arXiv:2204.07580*, 2022.
- Mohammad Shoeybi, Mostofa Patwary, Raul Puri, Patrick LeGresley, Jared Casper, and Bryan Catanzaro. Megatron-LM: Training multi-billion parameter language models using model parallelism. *arXiv preprint arXiv:1909.08053*, 2019.
- Antoine Simoulin and Benoit Crabbé. Un modèle Transformer Génératif Pré-entraîné pour le _____ français. In Pascal Denis, Natalia Grabar, Amel Fraise, Rémi Cardon, Bernard Jacquemin, Eric Kergosien, and Antonio Balvet, editors, *Traitement Automatique des Langues Naturelles*, pages 246–255, Lille, France, 2021. ATALA. URL <https://hal.archives-ouvertes.fr/hal-03265900>.
- Shaden Smith, Mostofa Patwary, Brandon Norick, Patrick LeGresley, Samyam Rajbhandari, Jared Casper, Zhun Liu, Shrimai Prabhumoye, George Zerveas, Vijay Korthikanti, Elton Zhang, Rewon Child, Reza Yazdani Aminabadi, Julie Bernauer, Xia Song, Mohammad Shoeybi, Yuxiong He, Michael Houston, Saurabh Tiwary, and Bryan Catanzaro. Using

- DeepSpeed and Megatron to train Megatron-Turing NLG 530B, a large-scale generative language model. *arXiv preprint arXiv:2201.11990*, 2022.
- Saleh Soltan, Shankar Ananthakrishnan, Jack FitzGerald, Rahul Gupta, Wael Hamza, Haidar Khan, Charith Peris, Stephen Rawls, Andy Rosenbaum, Anna Rumshisky, Chandana Satya Prakash, Mukund Sridhar, Fabian Triefenbach, Apurv Verma, Gokhan Tur, and Prem Natarajan. Alexatm 20b: Few-shot learning using a large-scale multilingual seq2seq model, 2022. URL <https://arxiv.org/abs/2208.01448>.
- Aarohi Srivastava, Abhinav Rastogi, Abhishek Rao, Abu Awal Md Shoeb, Abubakar Abid, Adam Fisch, Adam R Brown, Adam Santoro, Aditya Gupta, Adrià Garriga-Alonso, et al. Beyond the imitation game: Quantifying and extrapolating the capabilities of language models. *arXiv preprint arXiv:2206.04615*, 2022.
- Emma Strubell, Ananya Ganesh, and Andrew McCallum. Energy and policy considerations for deep learning in nlp. In *Annual Meeting of the Association for Computational Linguistics*, 2019.
- Jianlin Su, Yu Lu, Shengfeng Pan, Bo Wen, and Yunfeng Liu. RoFormer: Enhanced transformer with rotary position embedding. *arXiv preprint arXiv:2104.09864*, 2021.
- Ilya Sutskever, James Martens, and Geoffrey E. Hinton. Generating text with recurrent neural networks. In *International Conference on Machine Learning*, 2011.
- Zeerak Talat, Aurélie Névéol, Stella Biderman, Miruna Clinciu, Manan Dey, Shayne Longpre, Sasha Luccioni, Maraim Masoud, Margaret Mitchell, Dragomir Radev, Shanya Sharma, Arjun Subramonian, Jaesung Tae, Samson Tan, Deepak Tunuguntla, and Oskar van der Wal. You reap what you sow: On the challenges of bias evaluation under multilingual settings. In *Challenges & Perspectives in Creating Large Language Models*, 2022. URL <https://openreview.net/forum?id=rK-7NhfSIW5>.
- Yi Tay, Jason Wei, Hyung Won Chung, Vinh Q Tran, David R So, Siamak Shakeri, Xavier Garcia, Huaixiu Steven Zheng, Jinfeng Rao, Aakanksha Chowdhery, et al. Transcending scaling laws with 0.1% extra compute. *arXiv preprint arXiv:2210.11399*, 2022.
- Ryan Teehan, Miruna Clinciu, Oleg Serikov, Eliza Szczechla, Natasha Seelam, Shachar Mirkin, and Aaron Gokaslan. Emergent structures and training dynamics in large language models. In *Proceedings of BigScience Episode #5 – Workshop on Challenges & Perspectives in Creating Large Language Models*, pages 146–159, virtual+Dublin, May 2022. Association for Computational Linguistics. doi: 10.18653/v1/2022.bigscience-1.11. URL <https://aclanthology.org/2022.bigscience-1.11>.
- Ian Tenney, Patrick Xia, Berlin Chen, Alex Wang, Adam Poliak, R Thomas McCoy, Najeon Kim, Benjamin Van Durme, Samuel R Bowman, Dipanjan Das, et al. What do you learn from context? probing for sentence structure in contextualized word representations. In *International Conference on Learning Representations*, 2018.
- Francesco De Toni, Christopher Akiki, Javier de la Rosa, Clémentine Fourier, Enrique Manjavacas, Stefan Schweter, and Daniel Van Strien. Entities, dates, and languages:

- Zero-shot on historical texts with t0. In *Challenges & Perspectives in Creating Large Language Models*, 2022. URL <https://openreview.net/forum?id=BRzIS3GrIbc>.
- Ashish Vaswani, Noam Shazeer, Niki Parmar, Jakob Uszkoreit, Llion Jones, Aidan N Gomez, Lukasz Kaiser, and Illia Polosukhin. Attention is all you need. *Advances in neural information processing systems*, 30, 2017.
- Oriol Vinyals and Quoc V. Le. A neural conversational model. *arXiv preprint arXiv:1506.05869*, 2015.
- Alex Wang, Yada Pruksachatkun, Nikita Nangia, Amanpreet Singh, Julian Michael, Felix Hill, Omer Levy, and Samuel Bowman. Superglue: A stickier benchmark for general-purpose language understanding systems. In H. Wallach, H. Larochelle, A. Beygelzimer, F. d'Alché-Buc, E. Fox, and R. Garnett, editors, *Advances in Neural Information Processing Systems*, volume 32. Curran Associates, Inc., 2019. URL <https://proceedings.neurips.cc/paper/2019/file/4496bf24afe7fab6f046bf4923da8de6-Paper.pdf>.
- Ben Wang and Aran Komatsuzaki. GPT-J-6B: A 6 billion parameter autoregressive language model, 2021.
- Changhan Wang, Kyunghyun Cho, and Jiatao Gu. Neural machine translation with byte-level subwords. In *Proceedings of the AAAI Conference on Artificial Intelligence*, 2020.
- Shibo Wang and Pankaj Kanwar. Bfloat16: The secret to high performance on cloud tpus, 2019. URL <https://cloud.google.com/blog/products/ai-machine-learning/bfloat16-the-secret-to-high-performance-on-cloud-tpus>.
- Shuohuan Wang, Yu Sun, Yang Xiang, Zihua Wu, Siyu Ding, Weibao Gong, Shikun Feng, Junyuan Shang, Yanbin Zhao, Chao Pang, Jiaxiang Liu, Xuyi Chen, Yuxiang Lu, Weixin Liu, Xi Wang, Yangfan Bai, Qiuliang Chen, Li Zhao, Shiyong Li, Peng Sun, Dianhai Yu, Yanjun Ma, Hao Tian, Hua Wu, Tian Wu, Wei Zeng, Ge Li, Wen Gao, and Haifeng Wang. Ernie 3.0 titan: Exploring larger-scale knowledge enhanced pre-training for language understanding and generation. *arXiv preprint arXiv:2112.12731*, 2021.
- Thomas Wang, Adam Roberts, Daniel Hesslow, Teven Le Scao, Hyung Won Chung, Iz Beltagy, Julien Launay, and Colin Raffel. What language model architecture and pretraining objective works best for zero-shot generalization? In Kamalika Chaudhuri, Stefanie Jegelka, Le Song, Csaba Szepesvari, Gang Niu, and Sivan Sabato, editors, *Proceedings of the 39th International Conference on Machine Learning*, volume 162 of *Proceedings of Machine Learning Research*, pages 22964–22984. PMLR, 17–23 Jul 2022a. URL <https://proceedings.mlr.press/v162/wang22u.html>.
- Yizhong Wang, Swaroop Mishra, Pegah Alipoormolabashi, Yeganeh Kordi, Amirreza Mirzaei, Anjana Arunkumar, Arjun Ashok, Arut Selvan Dhanasekaran, Atharva Naik, David Stap, et al. Benchmarking generalization via in-context instructions on 1,600+ language tasks. *arXiv preprint arXiv:2204.07705*, 2022b.
- Jason Wei, Maarten Bosma, Vincent Y Zhao, Kelvin Guu, Adams Wei Yu, Brian Lester, Nan Du, Andrew M Dai, and Quoc V Le. Finetuned language models are zero-shot learners. *arXiv preprint arXiv:2109.01652*, 2021.

- Jason Wei, Yi Tay, Rishi Bommasani, Colin Raffel, Barret Zoph, Sebastian Borgeaud, Dani Yogatama, Maarten Bosma, Denny Zhou, Donald Metzler, Ed H. Chi, Tatsunori Hashimoto, Oriol Vinyals, Percy Liang, Jeff Dean, and William Fedus. Emergent abilities of large language models. *Transactions on Machine Learning Research*, 2022.
- Laura S. Westra and Bill E. Lawson. *Faces of Environmental Racism: Confronting Issues of Global Justice*. 2001.
- Langdon Winner. Technology as master. (book reviews: Autonomous technology. technics-out-of-control as a theme in political thought). *Science*, 1977.
- Langdon Winner. Do artifacts have politics? In *Computer Ethics*, pages 177–192. Routledge, 2017.
- Andrew Wong, Erkin Otles, John P. Donnelly, Andrew Krumm, Jeffrey McCullough, Olivia DeTroyer-Cooley, Justin Pestrue, Marie Phillips, Judy Konye, Carleen Penozza, Muhammad Ghous, and Karandeep Singh. External Validation of a Widely Implemented Proprietary Sepsis Prediction Model in Hospitalized Patients. *JAMA Internal Medicine*, 181(8):1065–1070, 08 2021. ISSN 2168-6106. doi: 10.1001/jamainternmed.2021.2626. URL <https://doi.org/10.1001/jamainternmed.2021.2626>.
- Haicheng Wu, Gregory Diamos, Jin Wang, Srihari Cadambi, Sudhakar Yalamanchili, and Srimat Chakradhar. Optimizing data warehousing applications for GPUs using kernel fusion/fission. In *2012 IEEE 26th International Parallel and Distributed Processing Symposium Workshops and PhD Forum*, pages 2433–2442, 2012. doi: 10.1109/IPDPSW.2012.300.
- Linting Xue, Noah Constant, Adam Roberts, Mihir Kale, Rami Al-Rfou, Aditya Siddhant, Aditya Barua, and Colin Raffel. mT5: A massively multilingual pre-trained text-to-text transformer. In *Proceedings of the 2021 Conference of the North American Chapter of the Association for Computational Linguistics: Human Language Technologies*, pages 483–498, Online, June 2021. Association for Computational Linguistics. doi: 10.18653/v1/2021.naacl-main.41. URL <https://aclanthology.org/2021.naacl-main.41>.
- Zhilin Yang, Zihang Dai, Yiming Yang, Jaime Carbonell, Ruslan Salakhutdinov, and Quoc V. Le. XLnet: Generalized autoregressive pretraining for language understanding. *Advances in Neural Information Processing Systems*, 2019.
- Aohan Zeng, Xiao Liu, Zhengxiao Du, Zihan Wang, Hanyu Lai, Ming Ding, Zhuoyi Yang, Yifan Xu, Wendi Zheng, Xiao Xia, et al. Glm-130b: An open bilingual pre-trained model. *arXiv preprint arXiv:2210.02414*, 2022.
- Wei Zeng, Xiaozhe Ren, Teng Su, Hui Wang, Yi Liao, Zhiwei Wang, Xin Jiang, Zhenzhang Yang, Kaisheng Wang, Xiaoda Zhang, Chen Li, Ziyang Gong, Yifan Yao, Xinjing Huang, Jun Wang, Jianfeng Yu, Qi Guo, Yue Yu, Yan Zhang, Jin Wang, Hengtao Tao, Dasen Yan, Zexuan Yi, Fang Peng, Fangqing Jiang, Han Zhang, Lingfeng Deng, Yehong Zhang, Zhe Lin, Chao Zhang, Shaojie Zhang, Mingyue Guo, Shanzhi Gu, Gaojun Fan, Yaowei Wang, Xuefeng Jin, Qun Liu, and Yonghong Tian. PanGu-*alpha*: Large-scale

autoregressive pretrained chinese language models with auto-parallel computation. *arXiv preprint arXiv:2104.12369*, 2021.

Susan Zhang, Stephen Roller, Naman Goyal, Mikel Artetxe, Moya Chen, Shuohui Chen, Christopher Dewan, Mona Diab, Xian Li, Xi Victoria Lin, et al. OPT: Open pre-trained transformer language models. *arXiv preprint arXiv:2205.01068*, 2022.

Zhengyan Zhang, Xu Han, Zhiyuan Liu, Xin Jiang, Maosong Sun, and Qun Liu. ERNIE: Enhanced language representation with informative entities. In *Annual Meeting of the Association for Computational Linguistics*, 2019.

Judit Ács. Exploring bert’s vocabulary, 2019. URL <http://juditacs.github.io/2019/02/19/bert-tokenization-stats.html>.